



X2-SERIES - 25063 / 40063

X2-SERIES PRO - 25063 / 40063



**Programmable brushless controllers for all types of models
(output power up to 15kW and 25 kW)**

Operating Manual

Programmable "brushless" controllers for all types of models TMM® 25063 – 3 / TMM 40063-3 **X2-series / X2-series PRO**



TMM® xxxx-3 X2-series / X2-series PRO range Controllers are outstanding, fully programmable controllers of the highest quality for "brushless" sensorless and sensor motors (BLCD motors) for models of cars, boats, submarines, airplanes, helicopters etc. They feature both unidirectional as well as bidirectional operation, and are manufactured in numerous modifications and variants - see below for an overview.

These controllers built up on their predeceasing Z-series controller range. They are already a 8th generation of brushless controllers. The well-proven methods of control and outstanding features from the previous series are certainly retained in these newest controller series.

To enable our customers to exploit the newest developments and satisfy new requirements, SW update of the PC programs as well as the firmware update of the controller can be carried out by the customer himself/herself though the internet at any time.

Advantages of the X2-series / X2-series PRO controllers:

- The controllers use new and very powerful **32 bit processors**, which have enough computing performance to satisfy all requirements and demands. That is also one of the reasons that these controllers have features and possibilities not achievable with simple controllers using 8-bit or even 16-bit processors.
- Controllers X2-series offer very high power, up to 700A / 63V (= 15 Lipol), that is **up to 44kW!**
(controller 63V / 700A has their own separate user manual, similar as small types up to 8,8kW)
- Choice of the model type (**airplane, car, boat, helicopter – all in one**) depends only on your controller settings, and both unidirectional as well as bidirectional operation is enabled (except for heli)
- Controllers have **4 memory banks** for parameter settings → choice of one of the 4 preset models is thus very easy
- **Internal Black Box** (logging device) is integrated into the controller (no additional cables needed, no additional cost)
- **the controllers can make use of „back data channel“** (telemetry) - real time telemetric data transfer from the model) **of some RC sets** (such as **HOTT by Graupner**) and can therefore send all the measured values to the transmitter in real time (to a display unit connected to the transmitter)
- Very clear indication of different states of the controller using 4 LED 
- When connected to PC, both saved data as well as warning and error notifications are transferred from the controller to the PC
- Controller can send all the measured (logged) values into PC in real time (**only PRO version**)
- It is possible to reduce power for both reverse as well as forward gear (current reduction to preset value)
- Extremely fine **throttle step 2048 values** (steps)
- Very high maximal motor revolutions (up to **250 000 rpm** for a 2 pole motor)
- **Automatic sensor setting** when sensor motors are connected → the problematic "phasing" of sensors and phases on motor is therefore not needed, the sensor position is also optimized; it is possible to connect also other motors not just those recommended by EFRA
- Sensor motor controllers (marking **SE**) you can run with sensorless motors also – necessary only set correct motor type to parameters
- Very transparent and easy settings of parameters using PC with Windows (XP, Vista, 7, 8)
- You can update the controller with a newer firmware yourself from our website www.mgm-controllers.com, using your **PC, USBCOM_4** module and **CC_11** cable. This new feature is very useful and favorable. Controller may have additional features that were not available at the time of purchase. You may have actual version at all times. The same components will be used to set parameters and read-out of data from the controller.
- Controllers also support motors requiring higher working frequency of 32kHz (such as „Tango" motor by Kontronik etc.)
- Controllers support **NiCd, NiMH, Lipol, Li-Ion, A123, acid (Pb)** cells and possibly **any other new battery type** (universal settings) which may have not even existed at the time of the controller production
- Unmatched protection and management of accumulators Lipol / Li-Ion (*for these cell types this is of a fundamental importance*) as well as A123 cells and NiCd / NiMH
- Very smooth starts with sensor as well as sensorless motors
- Possibility to connect brake lights or flashing beacon
- They are standard manufacture in a version with a switch (*in a safe connection – as in all MGM compro controllers, damage of switch does not affect controller*)
- It is possible to choose from several variants and cooling with active cooling and water cooling
- It is possible to choose a variant with enhanced resistance to water and humidity (marked as **WP**) or with a 100% water resistance (marked as **WR**)

Table of content:

First steps	4
Basic Recommendations	5
Controller's connection	6
Basic description of controllers	7
Basic operational modes – choice of the Model type and Direction mode	9
Select Model Type and Memory Bank	10
Parameters description	11
Parameters setting / Data reading from controller	20
Internal Black Box (flying recorder)	21
Throttle limits setting	25
Start with automatic throttle limits	27
Start with programmed throttle limits	28
Back data transfer, telemetry (only for controllers marking „BC“)	28
Sensor motors and controllers („SE“ marking)	29
Automatic sensor setting procedure	29
Settings the Maximal revolution of the system (of the helicopter rotor)	30
Maximal revolution of the motor Settings	30
HELI modes	31
Technical data (valid for 25°C environment temperature)	33
Optional Accessories	34
Controllers marking	34
Available versions of X2-SERIES controllers + dimensions	35
Controller states indication and Error messages (firmware 5.0x and higher)	39
Sparking prevent when connect higher voltage	40
Feeding an external BEC from the traction battery	40
Protective and safety mechanisms of TMM® controllers	42
Update SW inside the controller (firmware)	43
Installing and using program Controller 2	45
Update of program Controller 2	45
Accessories	46
Content of delivery	47
Product Warranty	47
Service and Technical Support	47

Note:

Content..... all items are available quickly by **CTRL+ left mouse button**.

blue underlined all like this marking texts in manual quickly jump, by **CTRL+ left mouse button**, to corresponding content (cross reference).

In the Manual in „pdf“ format on these marking texts standard cursor changed to hand symbol (). In this case only click to **left mouse button**, (without **CTRL**), caused jump to corresponding content (cross reference).

(\$NA) parameters or features parking by this symbol are not available in this moment. As soon as will be available, you can download and update new firmware for your controller – please watch information on our web.

In this manual are described general things about this line controllers. Exceptions for each type of model are described in separate chapters or differences are highlights.

Separate chapters are devote to technical specifications and related things.

First steps

(as simply and quickly as possible to start)

To start the controller to operate, highly recommended you read at least "[Basic recommendations](#)".

Further do the following steps:

- 1) Install the program „**Controller 2**“ version 2.x.x (from the CD or from the company's website <http://www.mgm-controllers.com/downloads.html> , see "[Installing and Using program Controller 2](#)"
- 2) Run the program „**Controller 2**“
- 3) Connect the controller **using the suitable cables and connectors ***) to the battery, as well as to the motor (motor you can also soldered)
- 4) Connect the controller to the PC using the USBCOM 4 module and the cable CC_11 (motor may or may not be connected)
- 5) Turn on the controller
- 6) Set requested type of model by choice memory bank, see "[Select Model Type and Memory Bank](#)" and write to the controller. Now you have chosen the correct model type and set default average values of parameters, including automatic limits. For the first experiments (tests) do not (but of course you can) nothing more set - except running the sensor motors and heli modes. In these cases is necessary to proceed according to the instructions in the appropriate chapter, i.e. "[Sensor motors and controllers](#)" and / or "[HELI modes](#)" and "[Settings the Maximal revolution....](#)".
- 7) Disconnect the controller from the PC
- 8) Connect the controller to the throttle channel of the receiver
- 9) And you can start now (mode "**Automatic throttle limits**" and automatic switch-off voltage "**Automat 78%**"

If you have the controller **with the model type marking** (e.g. **car**), this basic setup option preset from factory and therefore sufficient to perform the steps 3), 8) and 9).

You can also use the "video tutorials" here: <https://www.youtube.com/user/mgmcompro/videos> , where are shown all essential procedures and operations.

Of course you will achieve optimal behavior of the controller tuning parameters according to your model and your liking, there are already without studying and set other parameters cannot do.

Parameter setting by program „**Controller 2**“ is very simple and intuitive and enable easy and transparent setting all controller features for optimal behavior. If you wish to enjoy all the possibilities of the controller, please refer to the whole manual. To best use of all the controller's possibilities, read the whole manual if possible.

If you have set all parameters, include throttle limits (= programmed), you can start → [Start with programmed throttle limits](#).

*) Note:

- controllers in the basic version **with 5.0 MP JET** connectors on the power board to connect by flexible cables with a corresponding cross-section **with** soldered connector counterparts of MP JET 5.0
- controllers in version **with power cables** soldered on the power board to provide the free end of the suitable connectors
- controllers in the version with **crimping lugs (ring terminals)** screwed on the power board and pressed the power cables provide the free end of the suitable connectors

Basic Recommendations

- **!!! Shorten the cables between the battery and the controller as much as possible** (however not under 3 cm, there is a possibility of unsoldering wires from the controller) ! **The higher the power and the "faster" the used motor, the more important is this requirement ! Power cables must have corresponding cross section for the expected currents !**
- If you need to prolong the power conductors to batteries (distance between the controller and the batteries > 20 cm), it is necessary to solder additional capacitors (capacitors block **10x1G0.63**, see **Accessories**) as close to the controller (to "+" and "-" conductors of the controller) as possible. The capacitors must be **"very low ESR", 105°C** with at least double the capacity than those used in the controllers. This requirement is more important when controller working near the maximum of parameter limits (current as well as battery voltage).
- **!!! Use only quality and well dimensioned connectors for connect battery to the controller !** Very suitable and very reliable connectors are MP JET 2.5 – 3.5 – 6.0, resp. 8.0 mm, mm, which are dimensioned for currents up to 200 – 300A, they are very reliable. MP JET connectors feature small transition resistance, small dimensions and very firm connection (they do not come apart themselves as some other types do). We recommend to put the socket on the "-" wire (*black wire*) of the controller and the plug on the "+" wire (*red wire*). **Connectors of „plug" type 4mm, even golden-plated (4mm Gold Plated Bullet Connectors) or connectors of „Dean" type are discouraged for use.**
- **!!! NOTICE, reversal of battery poles will reliably destroy the controller !** (The damage however, may not show immediately, but in some later runs !) Therefore we recommend to put the socket on the "-" wire (*black wire*) of the controller and the plug on the "+" wire (*red wire*) – not the same part for „+" and also „-" pole → possibility of reversal input voltage polarity is smaller.
- **Never connect more cells (higher voltage) than is specified in technical data, you can damage controller.**
- In all cases use „antispark" resistor for first battery connection (charging of the filtering capacitors), see here: [Sparking prevent when connect higher voltage](#).
- The leads to the motor (*yellow wires marked "A", "B", "C"*) should be soldered directly to the motor or it is also possible to use the connectors mentioned above. If you decide to use connectors, this time solder sockets to the controller leads. **Short circuit of these wires together (when batteries are connected) or short cut of these wires to the feeding voltage results in damage or destroy of the controller !**
- **Short circuit motor cables or feeding cables to any other wires (driving signal, BEC, ...) caused damaging of the controller.**
- Insulate the connectors after soldering, e.g. using heat shrinking sleeve.
- **!!! Using of power supplies for controller feeding is strictly prohibited ! Only battery for feeding is permit.**
- **!!! Do not SWITCH OFF controller or PLUG OFF BATTERY when motor RUN or when it is still turning – that may lead to damage or destroy of the controller !!! This also applies to spontaneous disconnecting of the connector during operation, e.g. by vibrations!!!** This is why connectors should be chosen very carefully – see recommendation above.
- **!!! Be careful for using damaged motor or motor overloading, controller damaging is possible.**
- One controller can control only one motor.
- **It is necessary to cool the controller in operation with flowing air. Do not obstruct the access of cooling airflow to the controller, e.g. by packing the controller in foam**, especially when working near its limit parameters or choose types with external coolers (possibly also with a fan).
- It is recommended to measure current drawn from battery with charged battery and full load. **Only clamp Amperimeters using is permitted** (always for DC current, on the battery cables). **Never use Amperimeter inserted to the circuit** (i.e. between battery and controller) – **you can damage controller !** **It is convenient to use measurements carried out by the controller during the drive and their display using PC.** Please remember, that even one additional cog on pinion of the motor significantly increase the drawn currents. With acceleration set faster, currents in the start-up peak rise very fast, and that up to many times of the current in the steady state. It is necessary to do the measurement with the hardest batteries, which you wish to use in the set. This will prevent possible problems with overloading the controller, motor and batteries.
- Receiver and antenna should be placed as far as possible from the controller, the motor, the batteries and power leads.

Controller's connection

- Receiver and antenna should be placed as far as possible from the motor, controller, the batteries and power leads.
- Controller's **servocable #1** connect to the receiver, throttle channel.
- When you use (you have) controller with telemetry ("BC" version), connect **servocable #2** to corresponding channel of receiver.
- For OPTO versions (= both controllers, 250A and 400A) you must use external feeding for receiver and servos (external receiver battery, external BEC...)
- When motor rotate to other side than you need, you can swap two motor cables (only for sensorless motors !) or change rotation direction by parameter settings (parameter P54 "Motor basic spin direction").
- When you want use sensor motor ("SE" version of controller), make „**Automatic sensor settings**“ before first start.
- The controller switch is connected safety so that drop-out of BEC voltage is not possible if the switch fails (safe connection).
- Controller is turned-on by open contact of the switch or by connecting the accumulators (applies to versions without the switch).
- In all cases use „antispark“ resistor for first battery connection (charging of the filtering capacitors), for more information see to chapter: [Sparking prevent when connect higher voltage.](#)

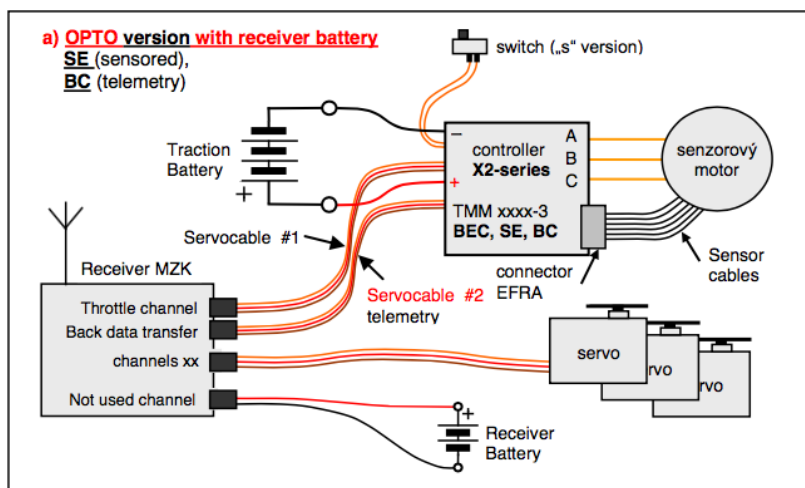

SECURITY WARNING:

Always disconnect the battery when not operating the model !!! Do not leave model with connected battery unwanted !!! If the controller is connected to batteries do not stay in the area in front of the model ! Rotating screw, propeller or uncontrolled car is very dangerous!!!

Do not charge batteries when connected to the controller! Controller turned off by a switch only, draws small current from the batteries.

- **NOTICE, reversal of battery poles will reliably destroy the controller !** (The damage however, may not show immediately, but in some later runs !) **Damaged controller can caused subsequently damaging of battery, their short circuit and/or eventually fire.**
- **Short cut of these wires together** (when batteries are connected) **or short cut of these wires to the feeding voltage results in damage or destroy the controller, with all adverse effects !**
- **Make sure that the motor is in a good condition. A faulty or damaged motor** (mechanical damages, shortcuts on winding, etc.) **may cause damage or destroy of the controller as well as the feeding cells, with all adverse effects !**
- **Disconnecting the connectors to battery or motor during operation** (motor is turning) **due to faulty or unsuitable connector leads to damage or destroy of the Controller, with all adverse effects !**

Basic description of controllers

Controller 25063-3:

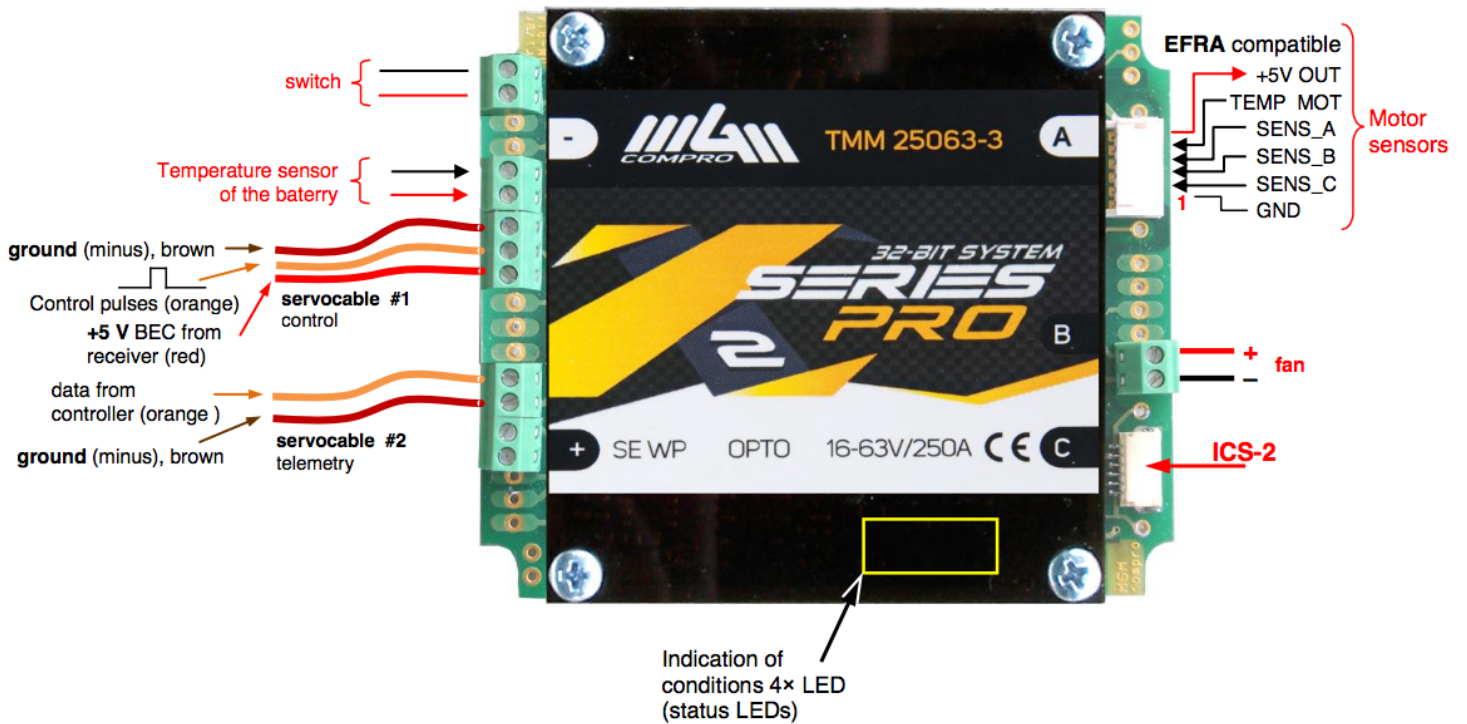

Controller 40063-3:

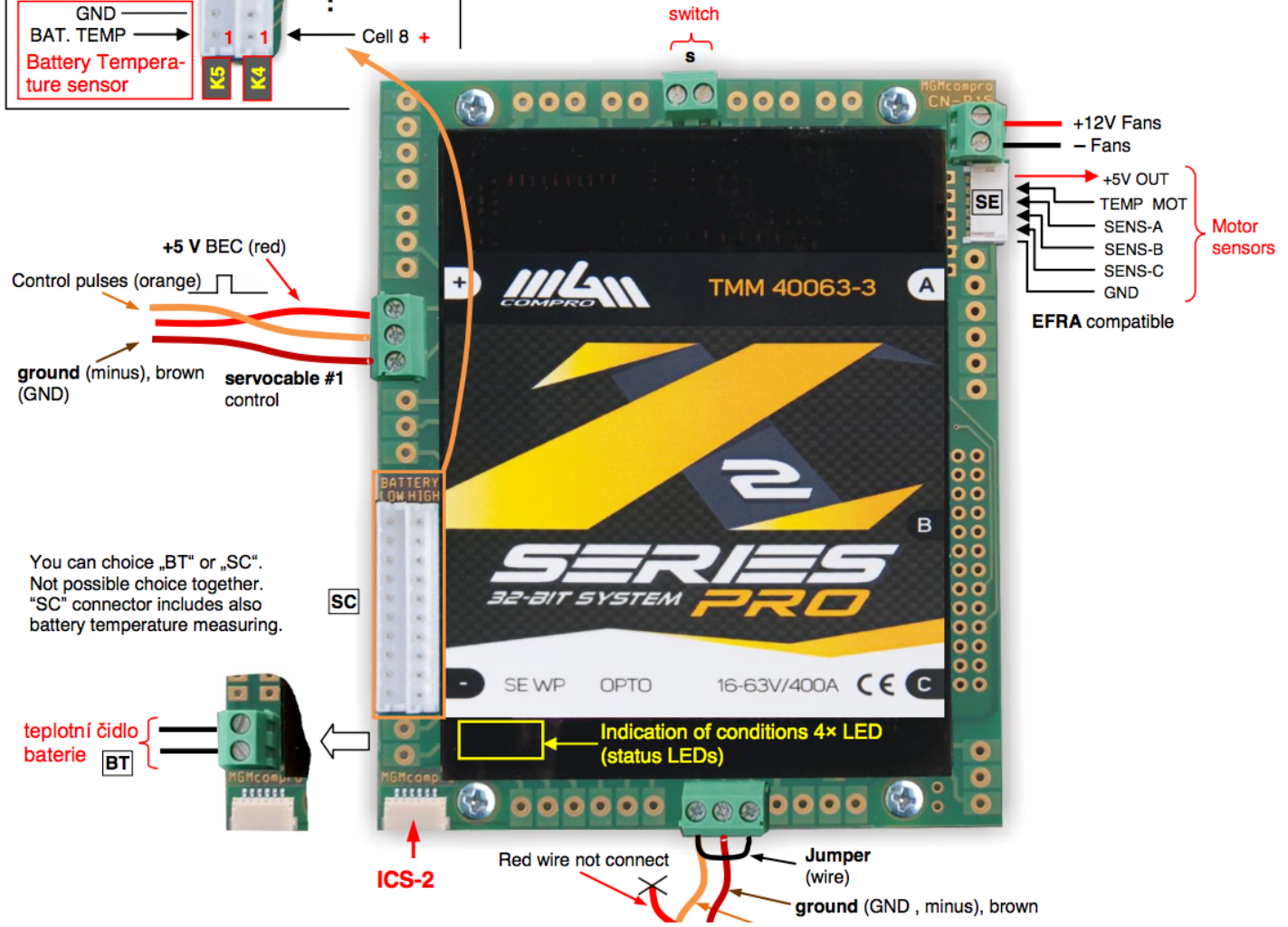
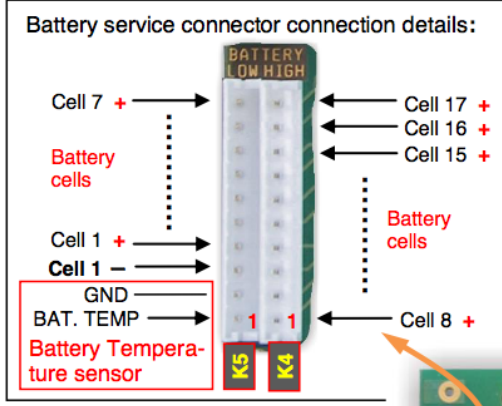
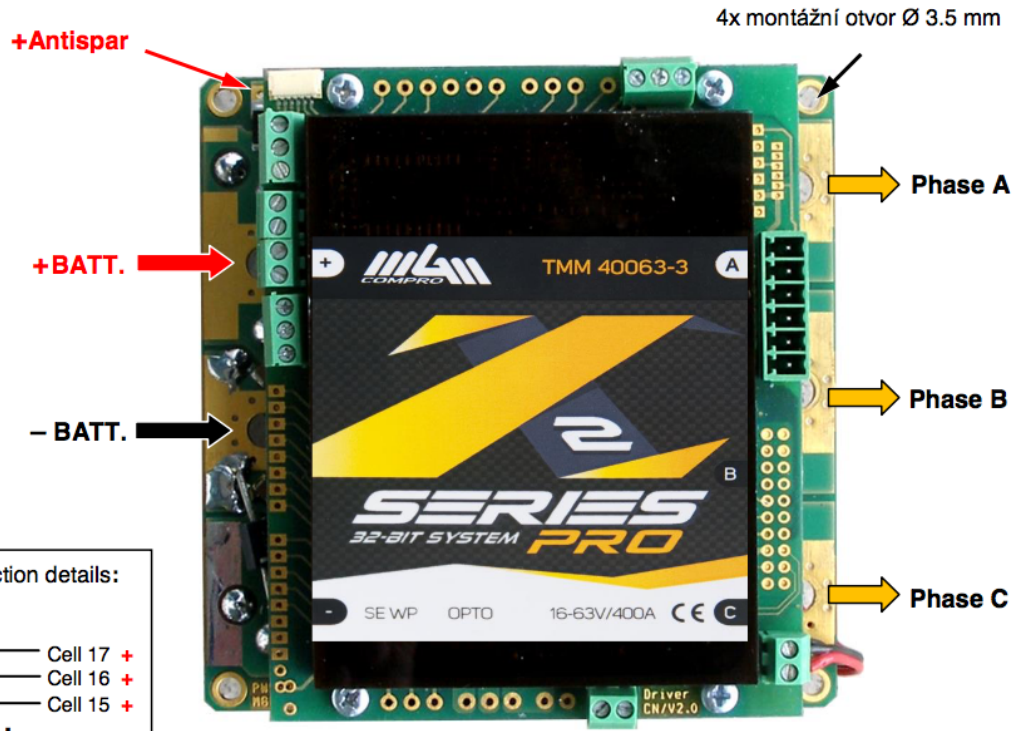

You can choice „BT“ or „SC“. Not possible choice together. „SC“ connector includes also battery temperature measuring.

Basic operational modes – choice of the Model type and Direction mode

- a) Aircraft one way** (fig. 1): Standard aircraft driving. "STOP" throttle position is identical with "brake" position. Transmitter without lock of STOP position.
- b) Aircraft bidirectional** (fig. 5, 6): This very special mode for aircrafts enabled, after landing, reverse motor(s) rotation direction and brake on very short runway (or run backward). Transmitter without lock of STOP position and/or with flying modes switch.
- c) HELI (one way)** (fig. 2): Standard helicopter driving. Transmitter without lock of STOP position and/or with flying modes switch.
- d) Boat one way** (fig. 1): Backward run is blocked by SW as well as by throttle position. Transmitter without lock of STOP position.
- e) Boat one way** (fig. 3, 4): Backward run is blocked by SW, throttle moving back from neutral is without effect. Transmitter with lock of STOP pos.
- f) Boat bidirectional** (fig. 5, 6): Bidirectional driving of boat, transition from one direction of rotation to opposite is instantaneous. Transmitter with lock of STOP position.
- g) Car one way** (fig. 7, 8): Backward run is blocked by SW, throttle moving back from neutral activate only brake (at the time brake light is lighting). No possible run backward. Transmitter with lock of STOP position.
- h) Car bidirectional** (fig. 7, 8): Standard bidirectional car driving, motor pass continually from run to braking (at the time brake light is lighting). Backward run is possible only after stop of model and throttle stick start from neutral position. Transmitter with lock of STOP position.

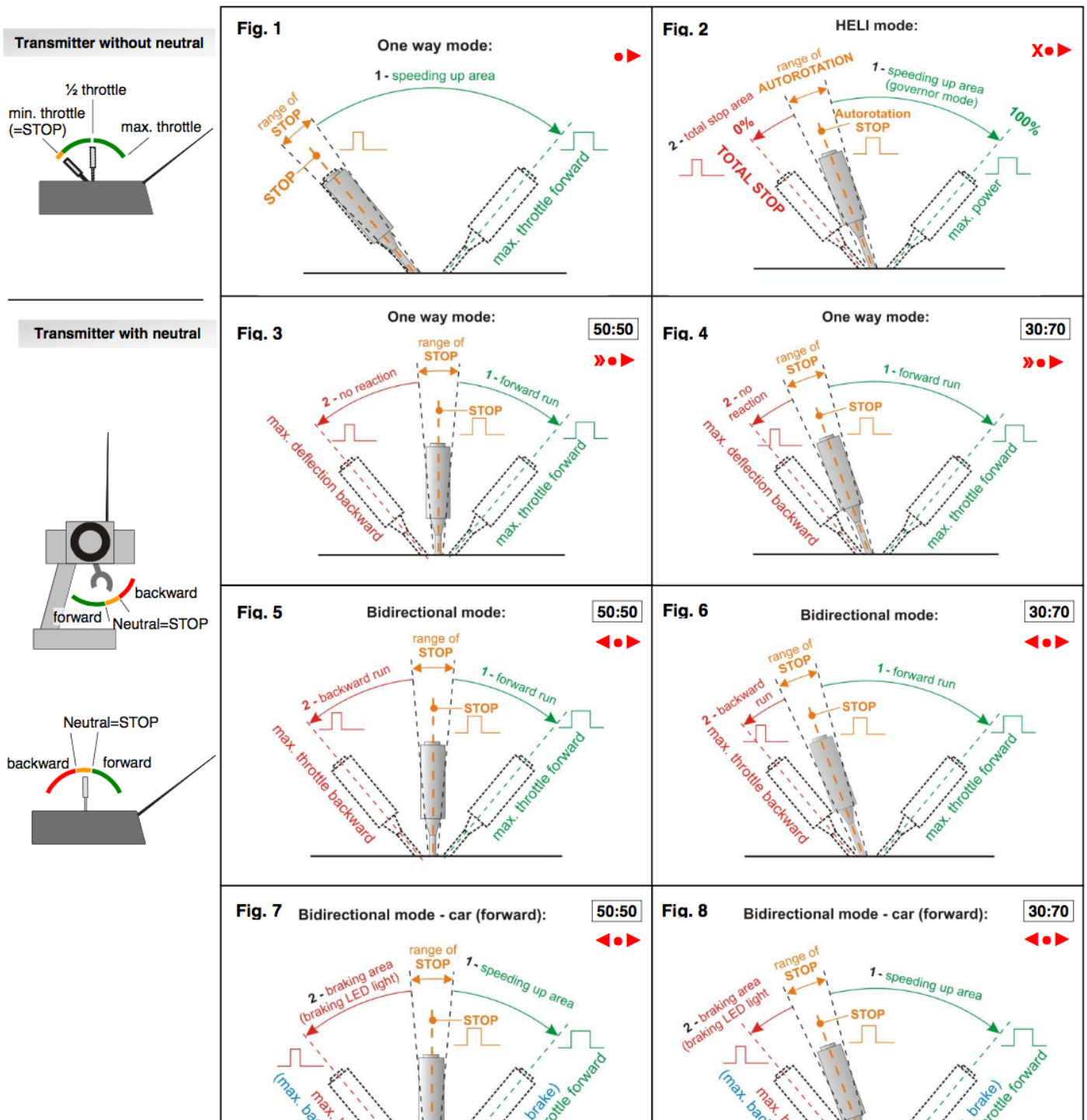

Select Model Type and Memory Bank

At the basic controller behavior has a major influence choice of the **Model type**. The controller allows selection of 4, respectively. 5 basic types of model. Any set of parameters, including the type of model, can be stored in any memory (**Memory bank**). **Along with the choice (with setup) of these two basic parameters cannot be change other parameters !**

Within the factory settings (default settings), are to individual memory banks assigned specific models types, including the basic settings, but you can at any time be changed at and rewritten. Thanks to the default settings (with preset average values) you can start using the controller almost immediately.

The default (factory) settings in the individual memory banks:

- Memory #1 = car (bidirectional)
- Memory #2 = boat (bidirectional)
- Memory #3 = aircraft (one way)
- Memory #4 = helicopter (heli mode #2)

To return to the default settings can be realized at any time by pressing the **default settings** button (**ATTENTION, that erases your settings and set all 4 memory banks to default values !**).

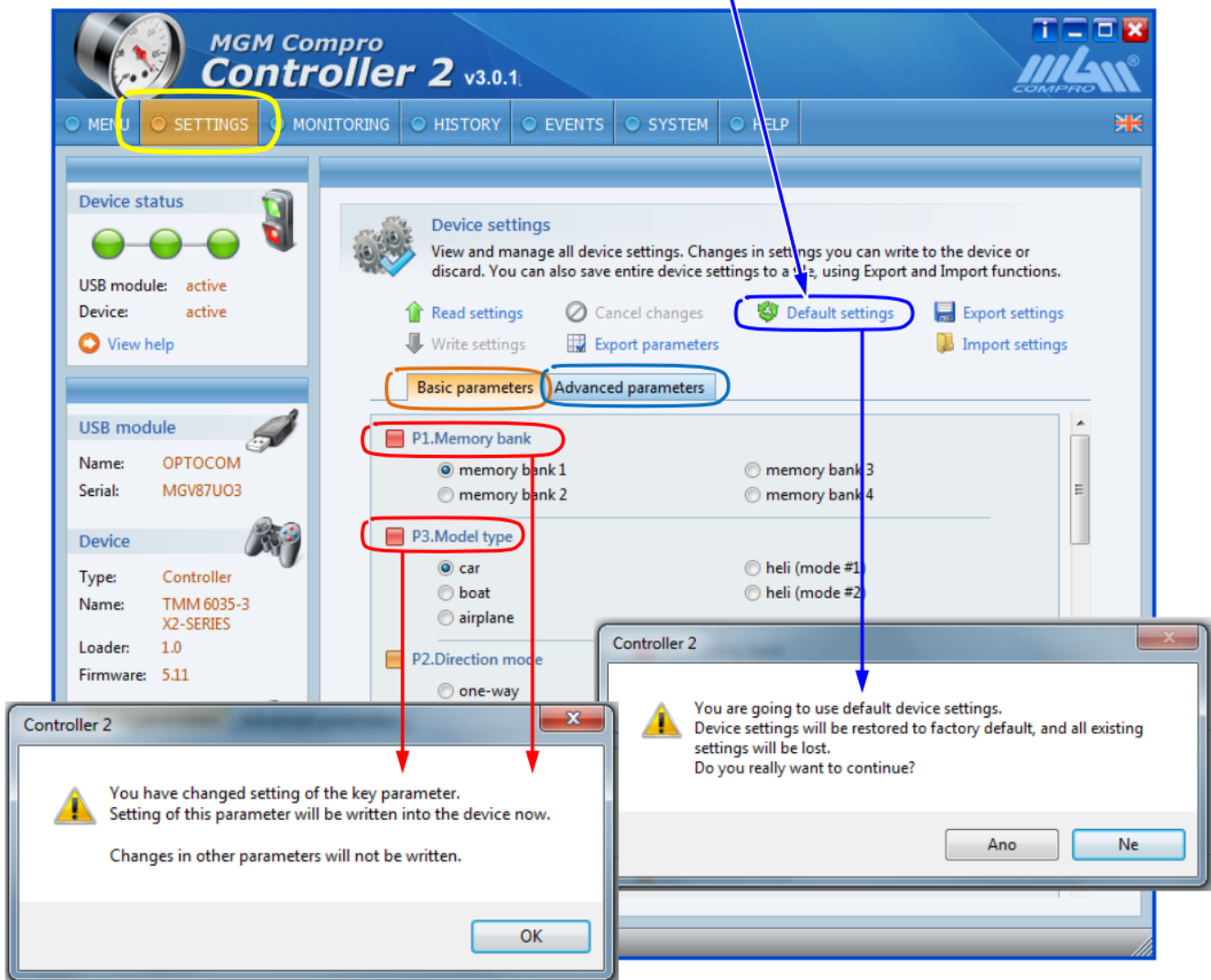

When you overwrite the **Memory bank** or **Model type**, the program updates the available parameters for that particular option and displays only the relevant parameters (e.g., if you choice model "Boat" will not be displayed parameters for the "Helicopters", etc.) In the main window are displays two sheets (folders). First, list **Basic parameters** and also list **Extended parameters (Advanced parameters)**. In many cases it is sufficient to optimize the performance or behavior of the drive in your model just set **Basic parameters** only. If you need more setting possibilities, for any reason, switch to the **Advanced parameter** list. Here you can set all the parameters for the selected model.

IMPORTANT:

When you want change some parameter(s), **necessary first select Memory bank** in which you want make changes. After this selection you can change all parameters by your needs and after pushing button "**Write settings**" will be these new values of changed parameters write to selected memory banks. All changes of any parameter are related to selected memory bank.

Parameters description

In this chapter are described all parameters, include parameters which are hidden for basic settings (Basic parameters).

P1: Memory bank – choice of memory

This special parameter makes possible choice of one of four pre-defined settings. Default parameters are set here for these types of models:

- (#1) car bidirectional
- (#2) boat bidirectional
- (#3) aircraft one way
- (#4) helicopter mode #1, constant revolution

Nevertheless you can change these parameters (in each memory bank) in any time by your request and needs, for example *aerobatic* (#1), *glide* (#2), *model F5B-1* (#3), *model F5B-2* (#4), etc.

You can change all parameters by memory bank select, very quickly and easy. Detail description you find in the chapter „[Select Model Type and Memory Bank](#)“.

P3: Model type

This second special parameter allows you to select basic type of the controller behavior depending on the model. You can choose from:

- car
- boat
- aircraft
- helicopter mode #1 – any constant revolution (governor) or PWM driving (set by P69) by throttle position
- helicopter mode #2 – preset constant revolution (governor), three values

Together with parameter „P2“ you can set one way or bidirectional running for selected type of model.

Together with parameter „P69“ you can set “constant revolution mode”.

For detailed description see "[Select Model Type and Memory Bank](#)"

Basic properties and behavior for different types of models:

»•► Car one way mode:

Car may run only forward – when move throttle stick rearward (from neutral position), only brake is activate – car never run backward.

◀•► Car bidirectional mode:

Car can run forward as well as backward.

If the car is standing, moving the throttle stick from neutral either forward or backward, will make it start up in the respective direction (forward or backward). If the car is already moving, and you move the throttle stick in the opposite direction, it will start braking. The brake is proportional that is the further the throttle stick from neutral, the more intensive is the brake. The maximal intensity of brake (in the maximal position) may be set in parameter „P22 - brake“. During braking, even after the car stops it will stay that way and will not start up in the opposite direction. Therefore, if you are braking and wish to move in the opposite direction, it is necessary, after stopping, to first move the throttle stick to neutral and then towards the desired direction. Then will the car move in the desired (opposite) direction (after moving the throttle from neutral forward/backward). Connected brake lights are lit up during braking.

X•► Boat one way mode:

Boat may run only forward – when move throttle stick rearward (from neutral position), nothing happened, motor stop – no brake, no run.

◀•► Boat bidirectional mode:

Boat may run forward as well as backward. Transition from one direction is opposite, with speeds of deceleration and acceleration set in parameters „P18 - deceleration“ and „P16 - acceleration“. Function is symmetrical for both directions.

X•► Aircraft one way mode:

Throttle stick moving to forward motor start run. When moved to STOP position, motor stops and brake with set intensity („P23 – Brake intensity in Neutral (in STOP position)“) or only stops, without brake, when parameter set to “0” – [fig. 1 on the page 9](#).

◀•► Aircraft bidirectional mode (!):

With this special mode is possible reverse motor rotation direction (i.e. also direction of thrust) and is possible very strongly brake (after landing) – [fig. 5 and 6 on the page 9](#). It is possible use transmitter with Neutral throttle position. More safety is using transmitter without Neutral throttle position with change of flying modes by switch (as for helicopters).

X•► Helicopter (one way mode):

Motor speed (i.e. rotor rpm) controlling is possible by throttle stick, include autorotation position, total stop, constant rpm (governor mode) in range 50 – 85% of maximal set rpm, [fig. 2 on page 8](#). Controlling is also possible by switches of flying modes, depend on your practice. There is a choice of three different modes - see chapter "HELI modes".

P2: Direction mode

- One way
- Bidirectional

Except helicopters you can choice one way or bidirectional running.

P69: Control mode (only for HELI modes)

- direct motor PWM control
- constant rpm of the motor, governor mode

PWM:

Linear throttle – motor PWM characteristic – standard motor driving.

Constant revolution:

controller hold settled revolution on the output shaft, not depend on voltage and / or mechanical load.

For details see „[Maximal revolution of ...](#)“ a „[HELI modes](#)“.

P4: Throttle limits

- automatic – (throttle limits is necessary set for each turning on controller)
- programmed – (controller use saved learned throttle limits)

This parameter coheres with next parameters P6, P7 and P8. This mode (Automatic) is advantageous because you do not have to set or program anything even when you change the transmitter setting (on channel throttle) or use different transmitter or receiver. The disadvantage is that you have to show the controller the throttle limits after each turn on of the controller by moving the throttle forwards and backwards, respectively minimal and maximal throttle.

In most cases is better when controller remember real throttle limits. Necessary set this parameter to "Programed" and learn real throttle limits by way description for next parameters (P6, P7, P8)

P33: Throttle limits settings lock

- forbidden – blocks of unwanted rewriting of throttle limits (blocks "learning" of these values)
- allowed – permits learning of throttle limits (rewriting of parameters P6, P7, P8) from transmitter

P6, P7, P8: Throttle limits – throttle max. forward / neutral / max. backward (values in μs [microseconds])

- Full throttle Forward
- STOP (Neutral)
- Full throttle Backward (Full brake)

For correct controller reaction (by your image) is necessary unify throttle range (limits) of your transmitter with range throttle limits in your controller. **When you change the transmitter or the range of the throttle, or you change the receiver, you have to set the limits again.** This setting (unify) is possible make by these ways:

- a) Set controller's throttle limits to concrete values by program **Controller 2** (or let set default values). Change transmitter throttle limits by transmitter settings (neutral position, end points of throttle stick deflections) with controller settings – with this step help you controller's indication LEDs – exactly show current throttle position, see chapter "[Controller states indication, Error messages](#)".
- b) Controller learns real throttle limits directly by steps description in chapter "[Throttle limits settings](#)" (without PC connection).

P12: Neutral range (wide of STOP position) (values in %)

This parameter relate with previous parameters – this is area is interpret by controller as zone in which motor stop (not running).

Too narrow zone may not be reliably evaluated, too wide zone narrows the area of throttle regulation. With some types of transmitters, loosening of throttle potentiometer occurs during operation, which causes different position of neutral for transitions from „throttle forward“ and different from „throttle backward“. This mechanical shortcoming must be eliminated by either setting a significantly higher value of this parameter or even better by fastening the fastening nut of the throttle potentiometer.

When you set too wide zone, all is working correctly, but lost part of regulation range → lower gentle of regulation step.

P40: BEC voltage (parameter has no meaning for this type of controller)

- +5V
- +6V
- +7V (only for HV BEC version)
- +8V (only for HV BEC version)

Set of BEC voltage, 5V or 6V for standard S-BEC. Controllers with „HV-BEC“ can set 5V, 6V and also 7V and 8V, suitable for RC systems with feeding from 2 Lipol or A123 cells.

P42: Controller feeding (Type of cells / switching-off voltage)

Parameter set type of cells, include standard switch-off voltage. Monitoring each cell is possible select for some type of cells.

Also is possible set switch-off voltage as 78% of value in moment of connection battery.

Next possibility is selection of "universal cell" (UNI), when is possible set any value – this choice includes so much as type of cell, also cells which are not available in moment of controller production.

- Automat 78% – switch-off / power reducing for voltage drop to 78% of initial battery voltage
- Lipol (3,2V) – switch-off / power reducing for voltage drop to 3,2V / cell
- Lipol, monitors each cell – switch-off / power reducing for voltage drop to 3,2V / cell, necessary ext. module *)
- A123 (2,5V) – switch-off / power reducing for voltage drop to 2,5V / cell
- A123, monitors each cell – switch-off / power reducing for voltage drop to 2,5V / cell, necessary ext. module *)
- Nixx (0,8V) – switch-off / power reducing for voltage drop to 0,8V / cell
- Pb (1,8V) – switch-off / power reducing for voltage drop to 1,8V / cell
- UNI universal value – switch-off / power reducing for voltage drop to set value
- UNI, monitors each cell – switch-off / power reducing for voltage drop to set value, necessary ext. module *)

*) except 40063 controller - this type can measure each cell without external module, version EC.

P43: Number of cells

Set used number of cells for **Lipol**, **A123**, **Nixx**, **Pb** and **UNI** battery.

Not operate for **Automat 78%** - for this case is parameter afield.

P78: Battery capacity (value in Ah)

This enables possibility watch, in real time, discharging main battery in the model by "back data transfer" via Telemetry – as "fuel tank indicator".

P44: Cut-off voltage per cell (only for P42=UNI) (value in Volts)

P45: "Empty battery" behavior (when voltage drops below cut-off voltage)

- motor stop
- motor stop with brake
- motor power reduction

In case that controller switched-off motor, it is possible start again (slow) when battery voltage recovered a little, after some time.

P77: "Empty battery" in advance warning by voltage - when voltage drops below set limit (value in Volt – overall voltage)

Defines voltage (for one cell) for which is activate indication by external indication equipment (super brightness LED, etc.), connected via ICS-2, signal **BL-1**. In case correct settings you achieve, that coming discharging of the battery is indicate with enough advance for correct landing. Please, respect real discharging curves (characteristics) for used battery.

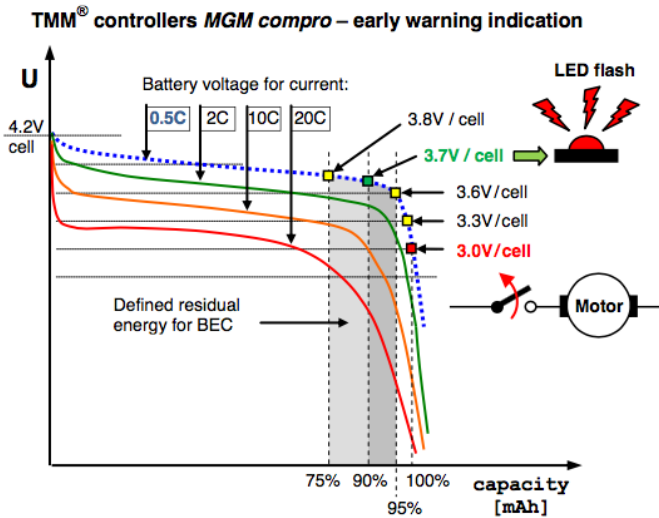

Switching-off voltage set to safety value corresponding with choice battery type (parameter P42, P43, P44) – example on the picture have set 3.0 V/cell for Lipol, red point on blue dotted discharging curve (start value for limitation of motor power).

Early warning voltage set to corresponding value with requested residual energy – example on picture have set 3.7 V/cell, green point on blue dotted discharging curve. Please, always respect discharging characteristics of used battery, see to values on battery producer datasheet. Always use discharging curve for lower current (lowest "C" rate), blue dotted curve for example on the picture. Residual energy is in this sample ca 10%.

In regard of unique feature of **MGM compro** controllers (re-computation of terminal battery voltage to its internal voltage), is this voltage (≈ residual energy) almost independent on internal battery resistance as well as on real battery discharging current, see „**Protective and safety mechanism**“.

We recommend this set voltage (≈ residual energy) check by one discharging cycle on the ground (not during real flight) and verify real value of residual energy, and eventually make little correction by real result.

Profitable can be association with each cell monitoring, by possibility of setting of parameter **P42, Battery type (Controller feeding)**..

Note: Some battery types (for example A123) have extremely flat discharging curve or, of even, negative (during discharging voltage increase up). In these special cases is not possible advantage to take early warning possibility.

P87: "Empty battery" in advance warning by charge – when consumed charge exceed set limit (value specified in % of battery capacity specify in P78)

In some cases it is preferable to monitor the quantity of residual battery energy by integration of discharging current. The system alerts to residual amount of fuel (energy in the battery) when reach the set value of the residual capacity in %. When drop below set value, indicates that both the controller status output **BL_1** (ICS-2 connector, pin 1) and by providing this information to the connected displays and/or display units. If you do not monitor the state of discharging, enter 0%.

Because the battery capacity varies depending to discharging current and also integration of current consumption is not perfectly accurate, we recommend the set of experimentally verified and corrected by the actual results.



P19: Maximal (allowed) current (value in %)

This parameter set top value of average motor current (in all cases equal or smaller than nominal controller current). Parameter is defined as % from nominal current. **Apply for both directions. Acceleration current peaks are tolerated. (P19=100% is without reduction).**

P20: Max. current Backward (PWM limit) Backward – additional motor PWM limiting for "backward" direction (% PWM)

Reduce engine power when turning back is an additional limitation of the maximum motor PWM to the set value.

The value is specified as a percentage PWM. **(P20=100% = without limitation of the motor PWM backward)**

Overall, therefore, backward power limited both by restricting maximum current (P19), and motor PWM limitations, regardless of the current. Applies the effect (the phenomenon), which occurs first.

Example: for controller with nominal current 250A (for example 25063-3)

P19=70%, i.e. current will be reduced to 70% from 250A, i.e. **to 175A** (value is valid for both direction)

P20 = 50%, i.e. current backward will be reduced to 50% of motor PWM, unless apply previously restriction set by P19 "Max. current".

P20 = 100%, i.e. current backward will be not additionally reduced. Reduction will be the same as forward direction (175A)

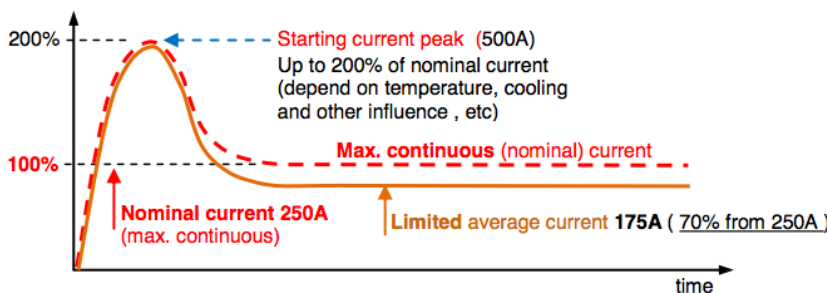

P46: Motor type

- BLDC Sensorless
- BLDC Sensors
- **BLDC with sensors - learning mode**

Possible is set **sensorless** as well as **sensor** motor (SE version only).

Next possibility is „**Automatic sensors settings**” include optimization of sensors position (**learning mode**). We recommend make this setting first in case of sensor motor. Partly you eliminate problems with no correct phase and sensors connection, partly you optimize sensors position – this is, at least, very recommendation, therefore sensor can be up to 20° out of optimize position inside some motors (and these not optimal position caused worse efficiency).

Procedure of this setting is described in details in chapter „**Automatic sensors settings**”.

P21: Freewheel

- No (freewheel OFF, no active, synchronous rectification mode ON)
- Yes (freewheel ON, with synchronous rectification mode ON)
- Yes (no synchro) (freewheel ON, without synchronous rectification)

Cars - Operation **with turned off freewheel** can be compared to a normal car with gear shifting. If you move throttle down, the engine brake active to new position of the throttle. The more you move throttle down, the more braking intensity. If you move the joystick (throttle) to neutral, the engine is braking (or stopped) very intensive. The engine basically follows (copies) of the control signal (joystick, throttle stick).

If the **freewheel is on**, every time the throttle move to a lower value (of course, also to neutral) the engine is disconnected (and don't braking) up until the engine inertia slows down the speed corresponding to the new throttle stick position. Then again, the engine is powered. It is actually electronic equivalent of mechanical freewheel.

In the case of **freewheel without synchro** behavior is similar to that in the case of "freewheel is on." The difference is that transitions between connecting / disconnecting the engine can be smoother in some configurations, but efficiency of the controller is little bit worse.

Aircraft / Boat / Helicopter

- With these model settings behavior is similar, but not so strong.

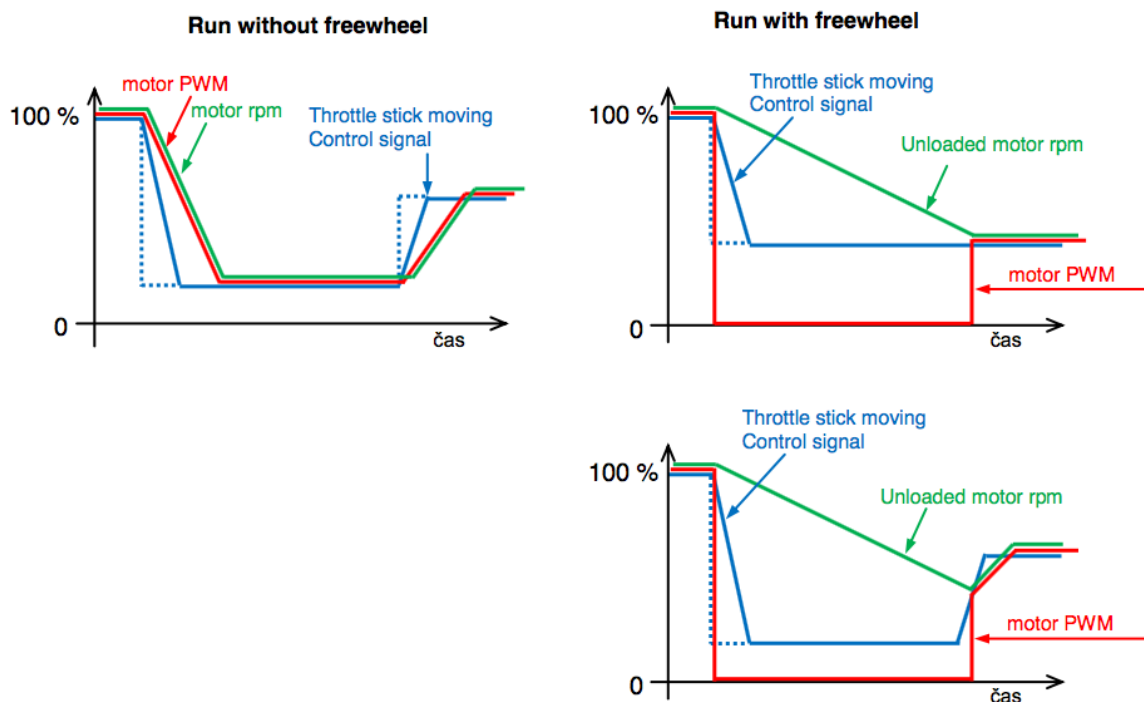

Freewheel and Brake, control type Car bidirectional, freewheel active:

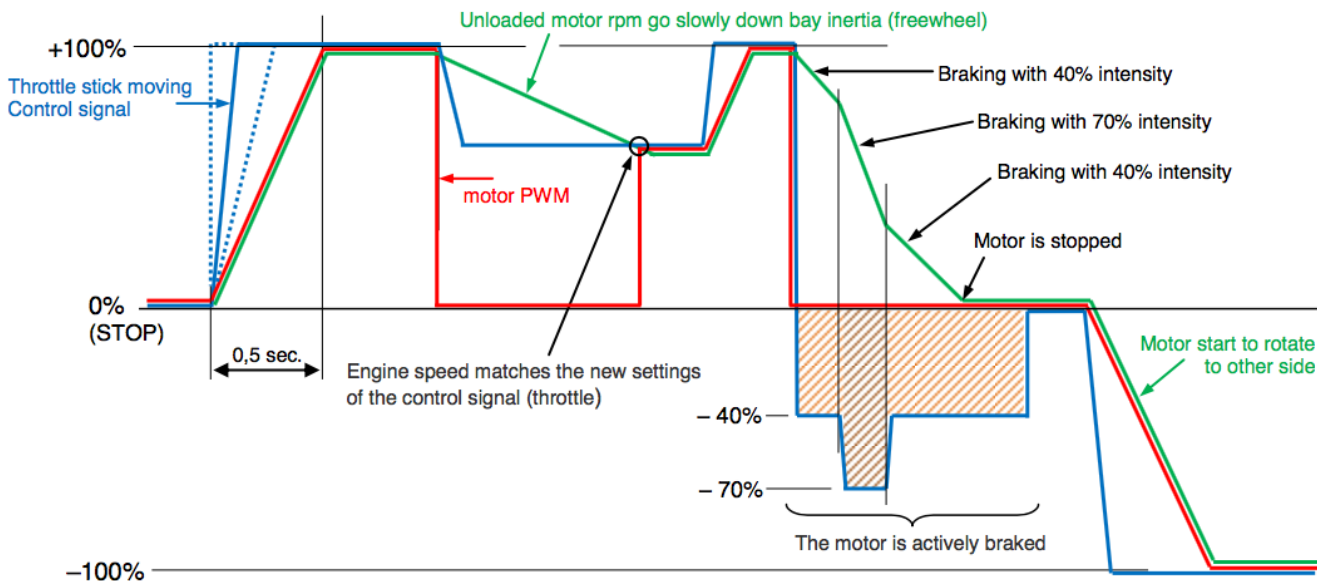

Freewheel, Brake and Brake in Neutral, control type Car bidirectional, freewheel active:

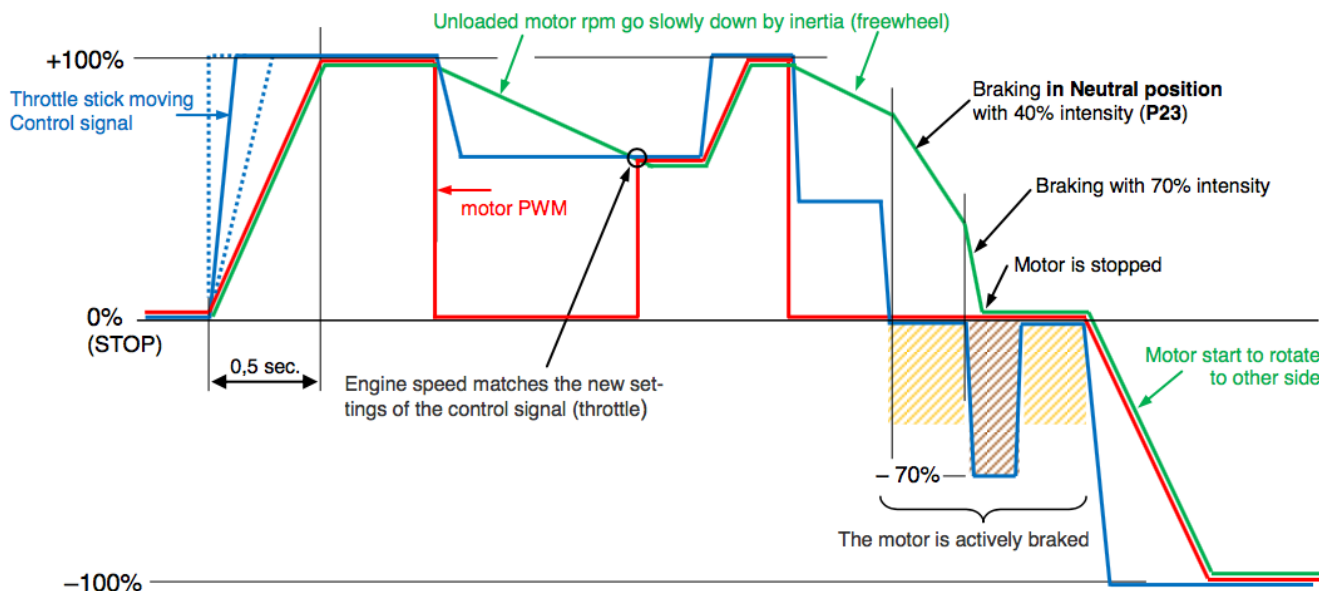

P47: Number of motor poles

This parameter is important for correct computing of mechanical output wheel rpm of the motor. When connect mechanical gear, necessary set also gear ratio in parameter **P48** – necessary for helicopters (for example). Without this value is not possible determine correct rpm.

Number of poles (magnets) – for this example PP=14

P51: Motor PWM frequency

- Automat
- 8 kHz
- 10 kHz
- 12 kHz
- 14 kHz
- 16 kHz
- 24 kHz
- 32 kHz

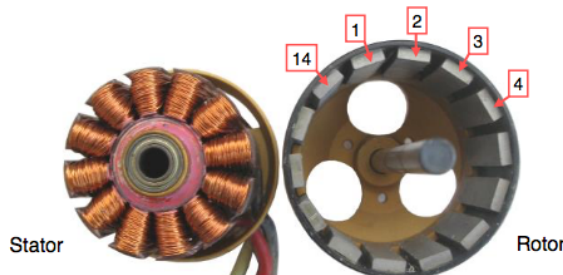

Using this parameter you set suitable frequency for motor control (PWM).

If you have a regular motor, set the lower frequency (8 - 12 kHz). If your motor requires higher frequency, set the corresponding value (for example Tango by Kontronik need 32kHz. no recommend use lower value. etc.) Mostly. these types called ironless motors. Higher frequency of motor

P52: Motor timing (value in ° (angle))

Automatic timing or 0° is recommended settings for most of motors. We recommend this setting also in cases when motor producers recommend some concrete angel, for example 10° (this is necessary for some other controllers, not MGM compro).

Automatic timing cannot be the best for some sensorless motors working on the border of its power possibility – they can lose synchronization (as for example AXI 53xx for highest power). In these cases is possible set higher timing 10 – 25°, this can little bit help. However, in these cases, better is used another motor or sensor motor.

P54: Motor basic spin direction

- Correct
- Reverse

This parameters sets the desired direction of motor revolutions without having to swap two motor cables, when the motor is turning the other way. The same effect as swapping of two motor cables (cables swapping is possible only for sensorless motors).

P83: Minimal starting power

Most of the BLDC and similar motors needs some minimum power to overcome the forces that magnets attract (hold) the rotor to the stator pole bits. If power supplied to the engine is too small (small movement of joystick, a small control voltage, ...), the engine does not exceed these forces and cannot spin, just vibrates (jerk) here and there.

By setting suitable value for this parameter is eliminated area of insufficient power and to the engine is supplied minimum power needed to spin. You will avoid engine vibration here and there in the smallest output. For the higher supplied power (according to the control signal), this parameter also does not apply (is not significant).

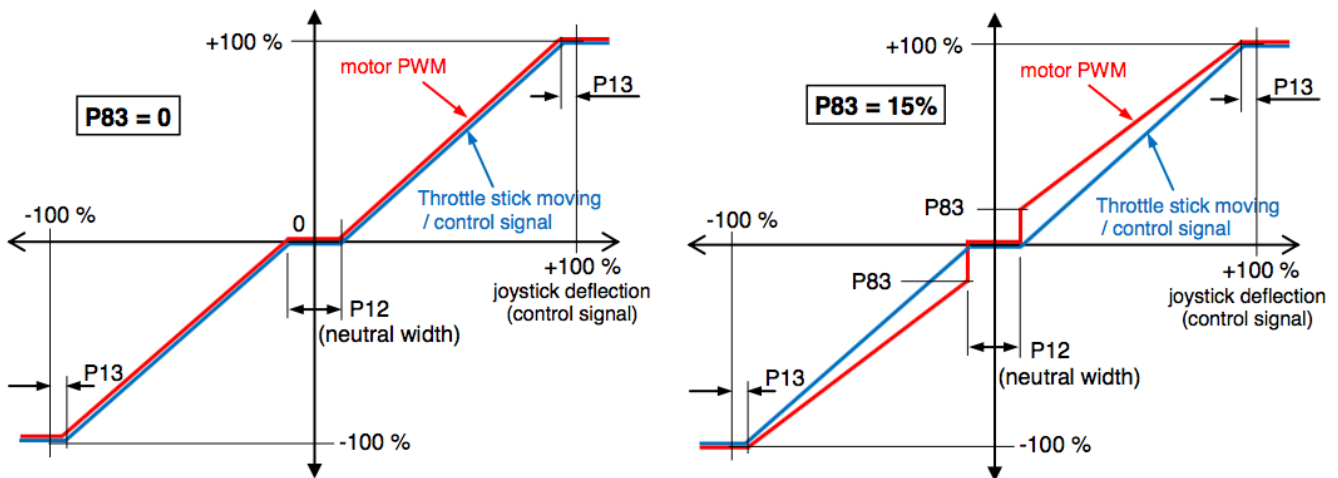
**P53: „Reversing or Brake“ Point (for cars only)** (relative dimensionless value)

- Car** - This point set moment (or better speed of run) for which is not activate brake when move throttle to max. brake position – and activate run to other direction. This is state when car is near to zero speed or stop and controller analyze this speed as “stopped”. When run on plain field, profitable is set the smallest value of this parameter. Another situation is when you braking during run down from hill – is possible that minimal speed (for full brake) is higher than nearly zero and controller cannot start run backward. Car is going too quickly and always (i.e. when move throttle from STOP position backward) is activate only brake. In this situation help set higher value of this parameter → hereafter is possible start reverse run (backward) also in situation when car speed is not near to zero.

P48: Mechanical gear

This parameter define general rate **X:1** between output motor wheel and mechanical machine output (for example rate of tooth of pinion and main cog-wheel for helicopters). Important for correct settings of real mechanical rpm (of the helicopters rotor, cars wheel etc.).

P49: Wheel diameter, tires diameter (for cars only) (value in mm)

- Car** - necessary is for correct displaying of car speed (km/hour), set value directly in program **Controller 2**.

P50: System RPM Limit (on the gear output) / Revolution 3rd throttle for HELI mode #2 (value in rpm)

This parameter make possible monitored (and not exceed) set maximal mechanical rpm (for example helicopter’s rotor rpm). This setting is important also for running with constant rpm (governor mode). Value is possible set directly (as number) in program „**Controller 2**“, more in chapter **“Maximal revolution of ...”**.

Max. rpm value not may exceed 250.000 for 2-poles motor, in any combination of number of motor poles and gear ratio.

In HELI mode #2 this parameter set revolution of flight mode $\equiv 3$ for throttle position in range between $1,73 \pm 2.0$ ms (resp. up to 2.3 ms). Controller indicate this range by lights **green LED**.

P86: Motor rpm limit (value in rpm)

This parameter allows to monitor (and not to exceed) the maximum revolutions of the motor shaft (motor protection).

P73: Revolution 1st throttle (only for HELI mode #2) (value in rpm)

This parameter set revolution of flight mode $\equiv 1$ for throttle position in range between $1,2 \pm 1,46$ ms. Controller indicate this range by **lights yellow LED**.

P74: Revolution 2nd throttle (only for HELI mode #2) (value in rpm)

P16: Acceleration (for HELI acceleration from Autorotation) (value in seconds)

Time necessary for increase rpm from zero to full value when move throttle from „STOP“ (neutral) position (for cars, boats or aircrafts) and from „Autorotation“ position for helicopters.

Car / Boat / Aircraft - set speed of starting of stopped motor from 0 to 100% of power

Helicopter - set speed of starting of stopped motor (**rotor always running !**) from 0 to 100% of power (from „Autorotation“ position)

P17: Acceleration from STOP position (For helicopters only) (value in seconds)

Helicopter - set speed of starting of stopped motor and also **stopped rotor** from 0 to 100% of power from „Total STOP“ position

P18: Deceleration (time of power decrease from 100% to 0%) (value in seconds)

Time necessary for decrease rpm from full value to zero (100% to 0) when move throttle from full throttle position to STOP. This is important mainly when going from full throttle forward to full throttle backwards (and vice-versa). That is, motor decelerates to zero with the set speed and then accelerates to the other direction with the speed set in parameter " P16" - acceleration.

If **Freewheel** parameter („P21“) is set, deceleration is not so strong.

Acceleration / deceleration (without freewheel):

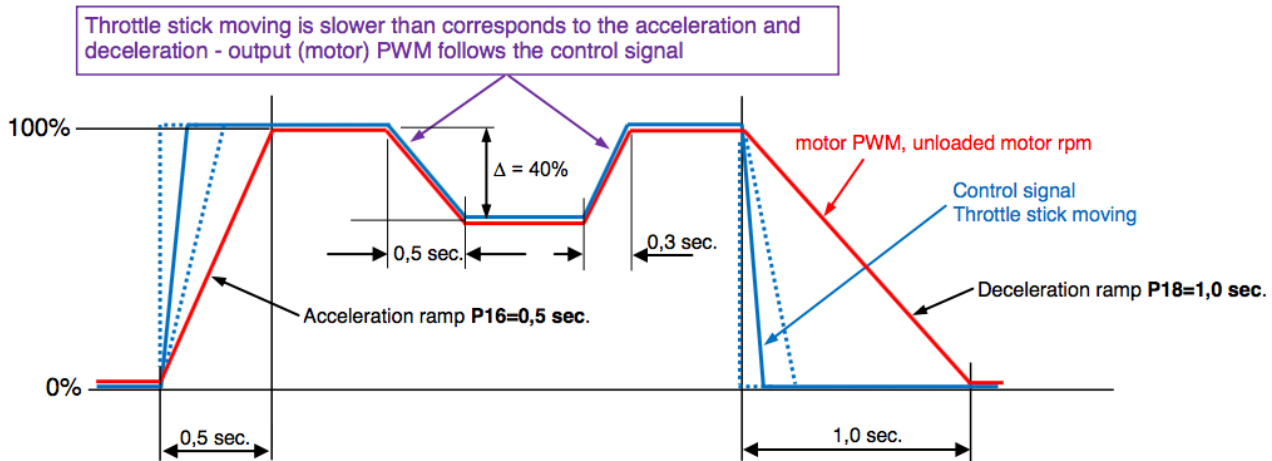

Acceleration / deceleration (without freewheel), control type: boat bidirectional:

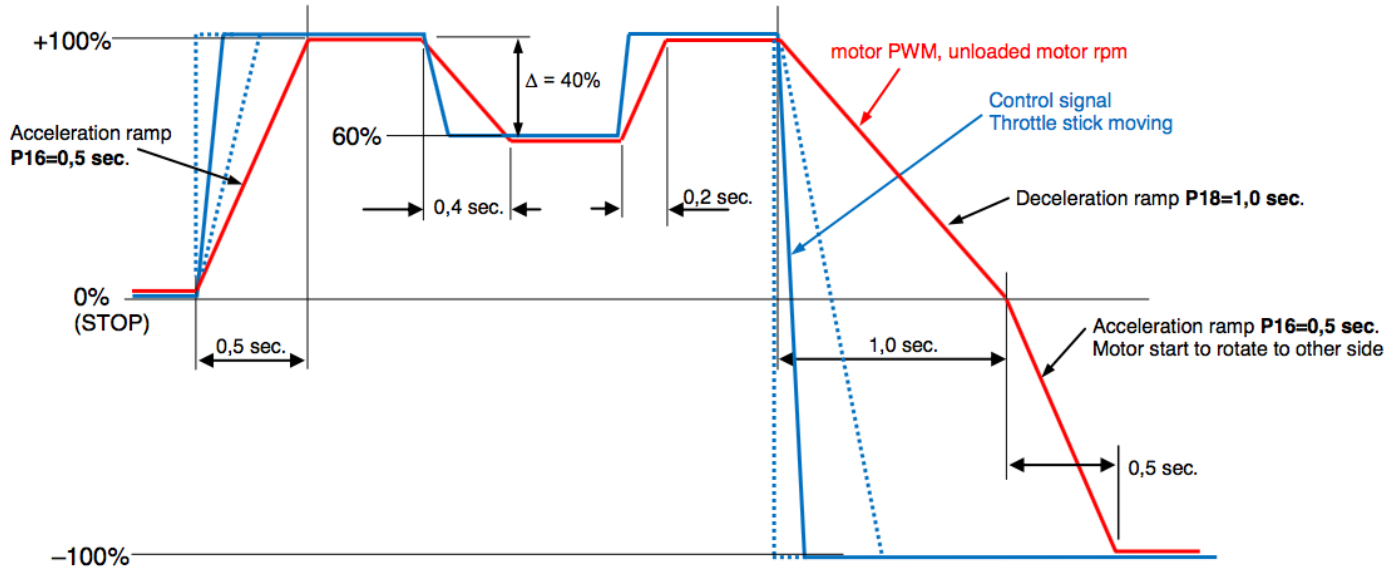

P22: Brake intensity (for cars only) (value in %)

Cars - enables to set the maximal force of proportional brake in the maximal deflection of the throttle stick (braking intensity) + possibility "no brake" (suitable for models with mechanical brake). Set according to your needs. If you wish automatically brake also in neutral, set parameter „P23“, Brake in Neutral. Fig. 7 and 8, page 8. Function is symmetrical for both directions.

P23: Brake intensity in Neutral - in STOP position (for cars and aircrafts only) (value in %)

Car - If you wish to automatically brake when the throttle stick is in Neutral position (STOP position), you may set the intensity of braking. If you do not wish to brake when in Neutral, set „0“ to this parameter (do not brake when STOP position). Increase braking force is possible any time by moving throttle stick to opposite direction (to max. brake position by P22 setting).

Aircraft - Parameter set braking intensity in STOP position of the throttle + not brake possibility.

Boat - setting of this parameter is without effect.

Helicopter - setting of this parameter is without effect.

P26: "Full brake" apply time (for braking in neutral throttle-STOP position) (value in seconds)

Define speed of activation of automatic braking in Neutral position.

P38: "Transmitter signal lost" masking period (time) (value in seconds)

Masking of short driving signal lost. Parameter is define time for which is mask signal lost and keep last correct value of throttle position (i.e. also power value). After the lapse of this time controller start reduce power (motor rpm), with or without brake. Intensity of braking in this situation is set in next parameter **P39**.

P39: Brake hardness (intensity) when "transmitter signal lost" (value in %)

Set brake intensity when lost driving signal, after adjusted masking time (**P38**) from 0% (not brake) to 100% of max. brake.

P71: BB data logging period (Internal BlackBox record period) / real time Monitoring

The standard write speed is 100 ms. With this rhythms are stored in the memory averaged measured values. Recording time is about 12 minutes. If you want to write faster (each 10 ms), averaging is faster (fewer samples), rapid of the details are better drawn, but recording time is 10 times shorter. You can select a record from the beginning or end (last 12 minutes).

You can also data record into the BB off and on "Monitoring", i.e., displaying data in real time on the PC screen via module USBCOM 4.

- 10 ms record from start
- **100 ms** record from start
- 100 ms from end record of last 12 minutes
- BlackBox off, Monitoring in real time enabled (available only for X2-series PRO version)

To internal BlackBox (data logger) are saved different data, for details see chapter "[Internal Black Box](#)".

Start of the record:

Joystick moving (control signal) from the STOP position after controller is turned-on

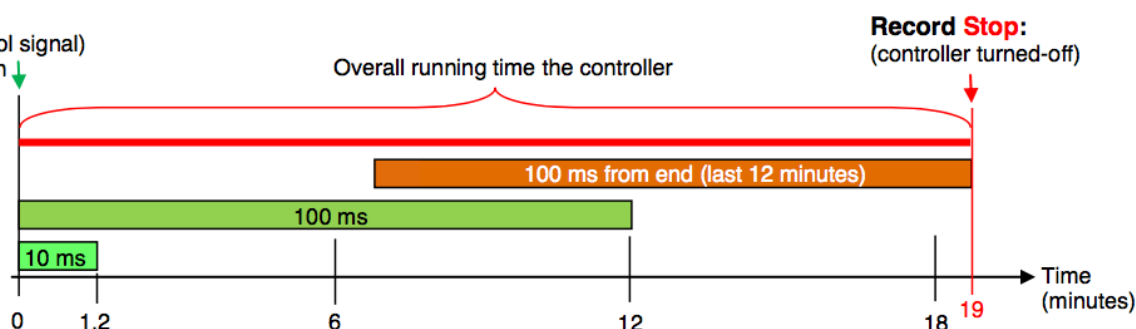
**P85: Data-logger recorded values, basic values and:**

- BEC data
- AUX1 data

As the number of values stored into the internal BlackBox is limited, you can choose (select) some measured values to be stored (at the expense of others). Which it will, this parameter specifies. Stored values are defined here: "[The data stored in the record](#)"

P14: Telemetry

- off
- MZK - TWIN
- GRAUPNER - HOTT

Controller can send data (all internal measured values and stored to BB) through receiver, by "back data channel" some of 2,4 GHz RC equipment (as HOTT from Graupner), to display connected to the transmitter, in real time. This bring many interesting possibilities, as well as increasing reliability and safety of models operations (you know battery voltage in real time, ... and you can react immediately to real situation). Turning-on this reverse transmission in no way affect to storing data in "Internal Black Box" for later evaluation.

Into transmitter are transmitted all the values stored in the internal BB ("[Data stored in the record](#)"), which data will be displayed depending on the display screen (unit).

P28: Motor temperature sensor

Available for sensor motors only.

- off
- Si diode
- 10k NTC (by EFRA recommendation)
- **KTY81-210**
- KTY84-151

When sensor is not connected, set "off".

P29: Battery temperature sensor

If your controller may measure battery temperature (only OPTO versions), is possible set sensor type:

- off
- Si diode
- 10k NTC

P31: Motor temperature limit (*value in °C*)

If your controller may measure motor temperature (only sensor motor types, marked SE) and you have connect some of defined sensors, you can set temperature value for which is motor switch-off.

P32: Battery temperature limit (*value in °C*)

If your controller may measure battery temperature and you have connect some of defined sensors, you can set temperature value for which is motor switch-off.

P37: Calibration of the motor temperature sensor (*value in °C*)

For easy replacement of the temperature sensor you can make its calibration at any time. If you specify this parameter in the current ambient temperature in which the sensor is calibrated (of course after stabilization of temperature), write them into the controller and turn-off and back turn-on the controller. If everything went correctly, the controller after this normally works and you can normally run, drive, etc. with calibrated temperature sensor. In case some problem occurs, the situation is indicates on the LEDs.

Can be combined with other parameter settings, i.e. including the present battery temperature sensor calibration can be calibrated the battery temperature sensor, see parameter P36.

Caution - for each memory bank be made separately (possible advantage of different sensors for different settings).

P36: Calibration of the battery temperature sensor (*value in °C*)

For easy replacement of the temperature sensor you can make its calibration at any time. If you specify this parameter in the current ambient temperature in which the sensor is calibrated (of course after stabilization of temperature), write them into the controller and turn-off and back turn-on the controller. If everything went correctly, the controller after this normally works and you can normally run, drive, etc. with calibrated temperature sensor. In case some problem occurs, the situation is indicates on the LEDs.

Can be combined with other parameter settings, i.e. including the present motor temperature sensor calibration can be calibrated the motor temperature sensor, see parameter P37.

Caution - for each memory bank be made separately (possible advantage of different sensors for different settings).

P13: Throttle limits range area (*value in %*)

Defines provision for terminal points settings for real driving signal.

Note: The graphical representation of these two parameters (P12, P13) is in parameter P83.

P79: Signal BL-1

May be use for control module of the brake lights, flash beacon, etc.

This output signal can be assigned to the several possibilities:

- brake lights / flash
- always ON (Continuous light)
- blinking (Continuous Flashing)

Parameters setting / Data reading from controller

If you wish to program the controller using PC or read out some values from the controller, it is necessary to connect the controller with your PC using **USBCOM 4** module, program „**Controller 2**“ which is supplied together with the communication module and available for download on website, and a connection cable **CC_11**.



- 1) start program **Controller 2**
- 2) connect **USBCOM 4** module to USB port of your PC and connect with controller by **CC_11** cable (cable CC_11 is connected to **ICS-2** marking connectors, in both equipment)
- 3) turn on controller by connect to suitable battery (and turn-on switch for version with switch)
- 4) you can communicate with controller now, read data, change parameters value, write changes parameters etc.

Don't forget select memory bank first, change parameters after this. Before switch-off write parameters by button "Write setting".

Control window of the program in PC:

The screenshot shows the 'MGM Compro Controller 2 v3.0.1' software interface. At the top, there's a 'Main action' button and a 'Language select' dropdown. Below is a menu bar with 'MENU', 'SETTINGS', 'MONITORING', 'HISTORY', 'EVENTS', 'SYSTEM', and 'HELP'. The 'SETTINGS' menu is highlighted in yellow. On the left, the 'Device status' sidebar shows 'USB module: active' and 'Device: active'. Below that, the 'USB module' section shows 'Name: OPTOCOM' and 'Serial: MGV87UO3'. The 'Device' section shows 'Type: Controller', 'Name: TMM 6035-3 X2-SERIES', 'Loader: 1.0', and 'Firmware: 5.11'. The main 'Device settings' area has a 'Control and command' button. A red box highlights the 'Device settings' controls: 'Read settings', 'Write settings', 'Cancel changes', 'Export parameters', 'Default settings', and 'Import settings'. Below this, there are tabs for 'Basic parameters' and 'Advanced parameters'. The 'Basic parameters' section is highlighted with a red box and labeled 'parameters setting area'. It includes:

- P40.BEC voltage (only for versions with BEC)**: Radio buttons for 5 [V], 6 [V], 7 [V], and 8 [V].
- P42.Battery type (Controller feeding)**: Radio buttons for 'automatic [cut-off = 78% of start voltage]', 'Li-xxx [cut off = 3,2V/cell]', 'Li-xxx (each cell monitoring)', 'NiCd/NiMH [cut off = 0,8V/cell]', 'Nixx (each cell monitoring)', 'A123 [cut off = 2,5V/cell]', 'A123 (each cell monitoring)', 'Pb [cut off = 1,8V/cell]', 'universal UNI', and 'UNI (each cell monitoring)'.
- P43.Number of the cells**: A numeric input field set to '1'.
- P44.Cut-off voltage per cell (only for P42=UNI)**: A numeric input field set to '0,1 [V]'.
- P21.Freewheel**: Radio buttons for 'OFF' and 'ON (no syn)'.

 A vertical scrollbar on the right is labeled 'Shift to other parameters hidden below and up'. Other callouts include 'controller type and version' pointing to the device name, 'Select from possibilities' pointing to the battery type options, and 'Parameter value set as number' pointing to the cut-off voltage input field.

Internal Black Box (flying recorder)

For correct using of controller's Black Box, set requested value for „BB data-logging period “ (P71). You can choice more quickly record with more details but shorter record (each 10 ms, i.e. 100× per second, record time ca 1,2 minutes) or slower and longer record (each 100 ms, i.e. 10× per second, record time ca 12 minutes).

Don't remember set correct number of motor poles for correct rpm value, respectively also gear ratio and tires diameter for correct computing of car speed.

Current version record first 12 minutes of flying (run) resp. 1,2 minutes for quick record. Record automatically stopped after this time. Record start when throttle is moved from STOP position after controller turn-on.
In the future will be possible switch record also for last 12minutes of flying (run).

When you want read recorded data, necessary connect Controller to PC and start program **Controller 2**.
Choice button „**HISTORY**“ and push „**Read**“.

The data reading from the controller are displayed simultaneously to a graph. Chart can be zoom in a separate window (better alternative). Use the icons in the upper right corner you can select individual parameters to the graph. Each variable can be assigned to the left or right axis graph (different scales). The curves associated to the right or left vertical axis, whose properties can be adjusted, as appropriate, may be wearing points for better orientation.

At the same time can be selected in the graph (displayed) up to 10 different variables. Graph can be zoomed, and select part and magnified, magnified graph can move, **save to a file in xls** format, which is currently stored and parameter settings. Also, it can be stored in **hdf** format, which you can always read back into the program and view the graph. To work with chart are available as an option similar to load data from the controller.

Note: In order to store all data, including parameter settings, you must save the data to a file while the controller is turn-on !

Recorded data see "Data stored in the record to an internal Black Box" to other sides.

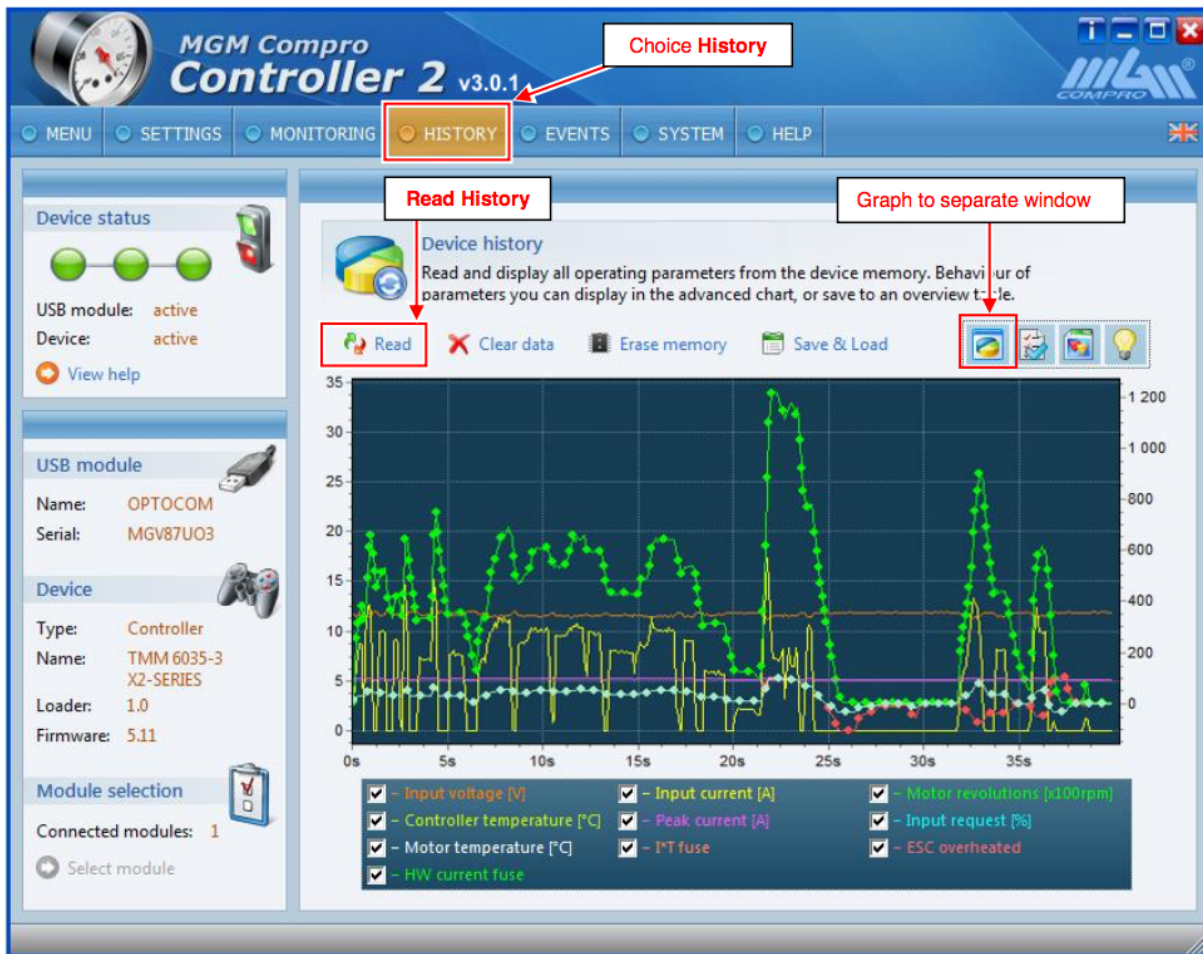

The image shows three instances of the 'Chart settings' dialog box. The first instance on the left has the 'Parameter selection' tab active, showing a list of parameters with checkboxes and radio buttons for chart axes. The middle instance has the 'Curve settings' tab active, showing options for 'Left axis curve' and 'Right axis curve', including 'Show curve points', 'Colour point', and 'Point shape'. The third instance on the right has the 'Chart appearance' tab active, showing 'Chart color scheme' options (bright and dark) and a 'Show grid in chart' checkbox. Red arrows point from these settings to the main chart area below.

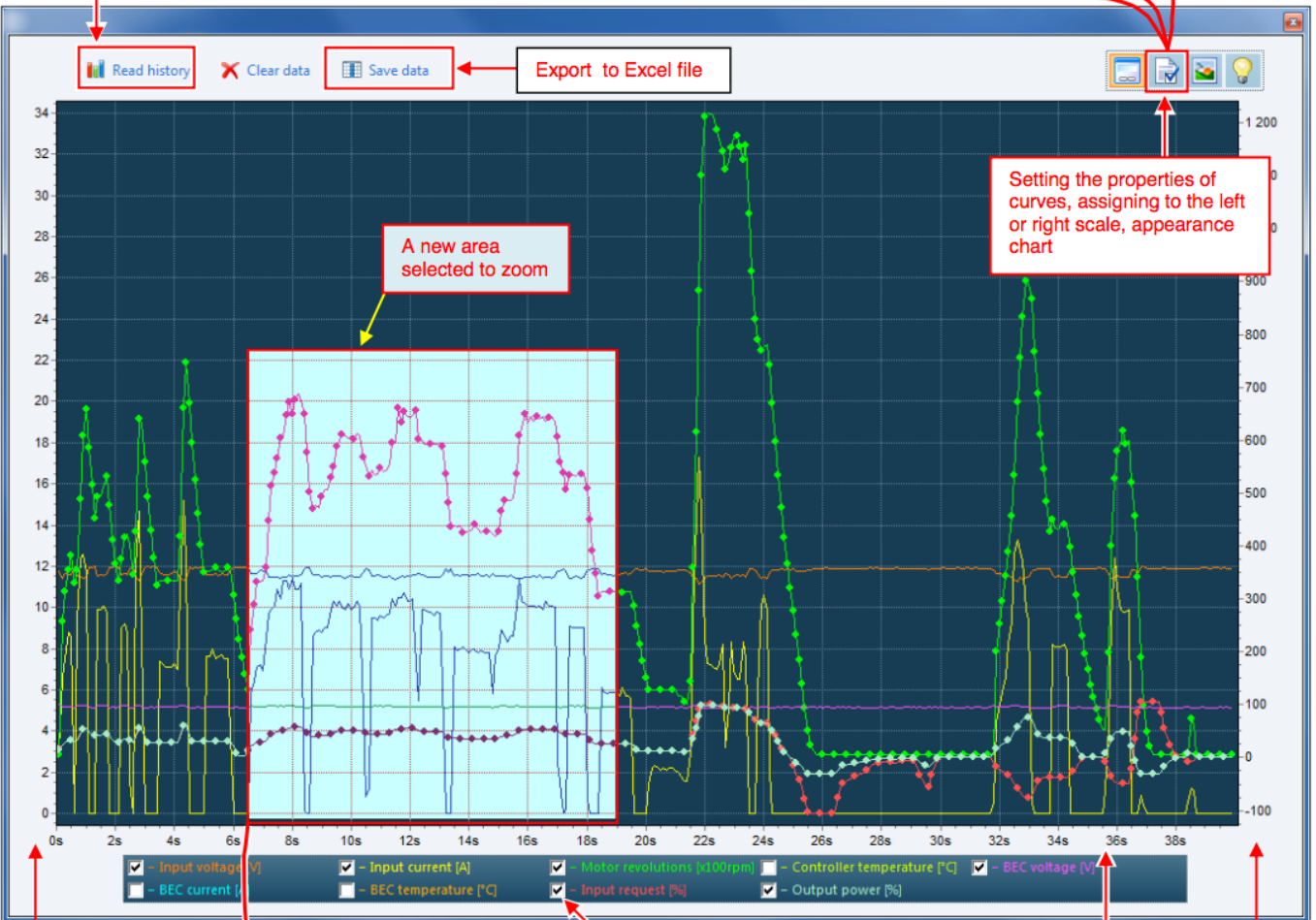

This block shows a zoomed-in view of the chart area. Annotations include: 'The left vertical axis (scale)' pointing to the left y-axis; '„Switch-on“ and „switch-off“ selected variables' pointing to a specific data series; 'The right vertical axis (scale)' pointing to the right y-axis; 'Time axis' pointing to the x-axis; and 'Enlarged selected area' pointing to the zoomed-in region. The zoomed area shows a detailed view of the data series between 8s and 18s, with the left y-axis scale from 1 to 19 and the right y-axis scale from -50 to 750.

Evaluation (interpretation) parts of the record:

For greater clarity, the color and scale are changed to images on the previous page.

Here is shows a throttle (input command), the output power in % and current from about 11 to 40 second.

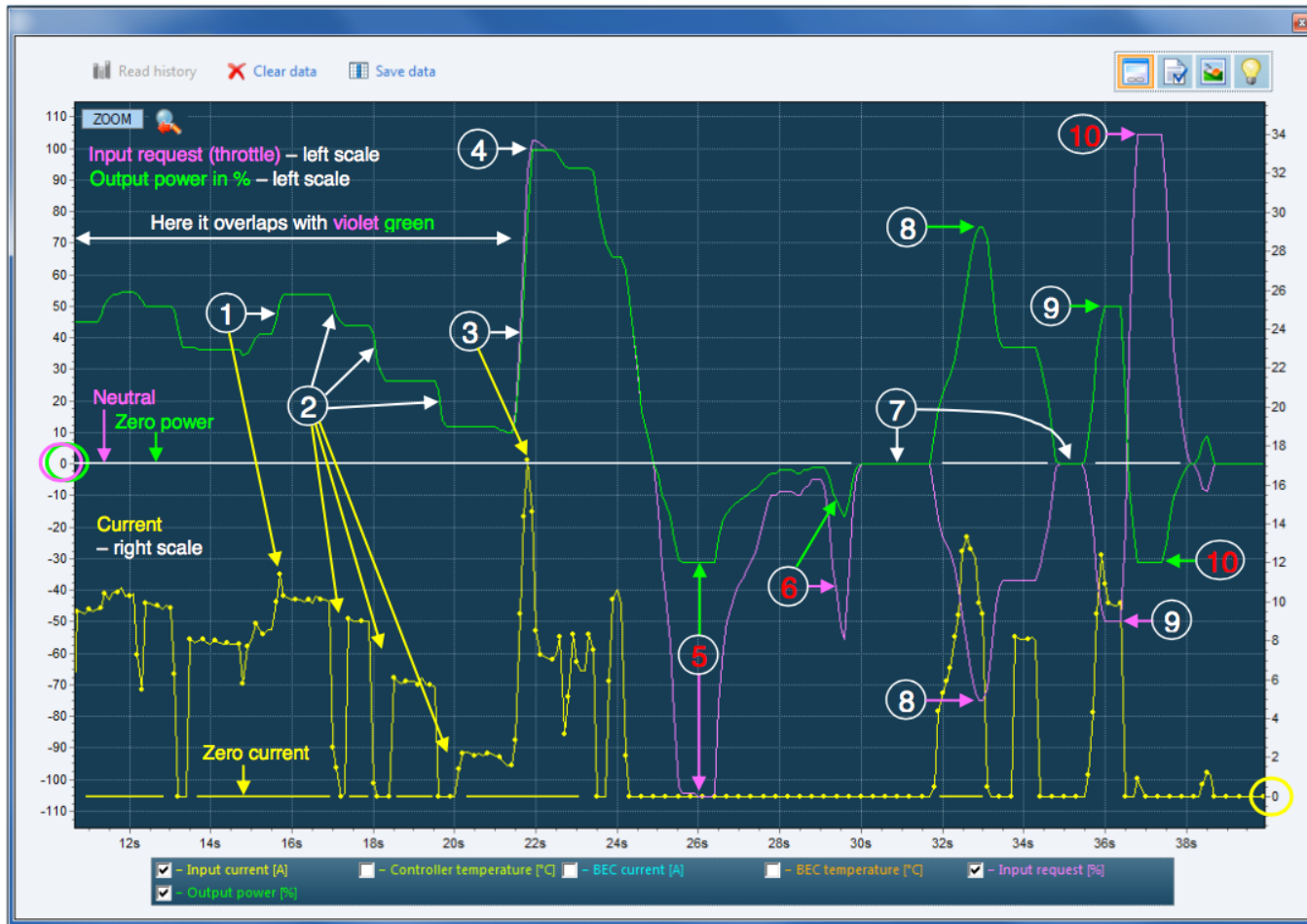

- 1 partial acceleration (from +42% to +54%) - output power practically follows the input command is a small current peak
- 2 throttle defend – current decreases during the reduction of power (rpm) to zero (freewheel on)
- 3 aggressive acceleration (from +10% to +100% (4)) - output power (motor PWM) goes to 100%, current peak is strong
- 5 full brake (input command is -100%) – output power goes into negative numbers, the brake is 30% (depending on settings) – battery current is zero
- 6 partial brake (input command is -55%) - output power goes into negative numbers, the brake is about 18%
- 7 neutral – output power is zero
- 8 ride backward, partial throttle (input command is -75%) - power goes to positive numbers, current flows
- 9 ride backward, partial throttle (input command is -50%) - power goes to positive numbers, current flows
- 10 full brake when driving backward (input command is +100%) - output power goes into negative numbers, the brake is 30% (according to parameters settings) – output power is zero

Note: negative currents flowing to the battery **under braking** are not displayed (shows zero current). It is displayed as "negative" output power in % only.

**Data stored in the record to an internal Black Box (all versions) /
The data displayed in real time (Monitoring) – available only for PRO version:**

ukládání / zobrazovaná data			komentář
Data:			
D1	Time	sec.	Time information is recorded in
D2	Input voltage	V	Average input voltage (traction battery voltage)
D3	Input current	A	Average battery current
Alternative data AUX1: parameter P85 choice			
D4A	Peak current	A	Peak current flowing through the phases (the controller and motor) in the PWM motor pulse
D5A	Internal battery voltage	V	Internal battery voltage - calculated value from the battery internal resistance and current
D6A	Internal main bus voltage	V	The internal voltage of the controller - information for service
Alternative data BEC: parameter P85 choice			
D4B	BEC voltage	V	The output voltage of internal DC / DC converter for external use
D5B	BEC current	A	The output current of internal DC / DC converter for external use
D6B	BEC temperature	°C	Internal DC/DC converter temperature
D7	Motor speed (×100)	rpm	Engine speed (engine mechanical rpm)
D8	Speed of system (× 100)	rpm	Speed of system (for gearbox), output shaft of gearbox rpm
D9	Input command	%	Control variables in % (input signal in %)
D10	The supplied power %	%	Value of the PWM motor - gives a very good image of the supplied power *)
D11	Input power of the controller	W	Input power the controller - the value calculated from the input voltage and current
D12	Car speed	km/h	Travel speed - calculated value from the engine speed, gear ratio and wheel diameter
D13	Controller temperature	°C	Temperature of the controller (power engine part)
D14	Motor temperature	°C	The temperature of the engine when the engine temperature sensor integrated in the winding
D15	Battery temperature	°C	The temperature of the battery, if the sensor is built into the pack
D16	Pulse current	A	Calculated peak current value (indicative value only makes sense if you do not display D8)
D17	Remaining battery capacity	%	Shows the remain battery charge in % (the rest of the fuel) - ONLY in MONITORING mode

Status information :

Active = value ~10 / iInactive = value 0

S1	Constant speed (rpm)	A / N	Activated by holding constant speed
S2	I*T pojistka	A / N	Activation when exceeding limit of peak (phase) current × temperature of the power components (FETs)
S3	Undervoltage	A / N	Activated when the average battery voltage drop below the set value
S4	Overcurrent	A / N	Activated when exceeding of current limits (from an average currents)
S5	Controller overheating	A / N	Activated when the controller temperature exceeds the set limit
S6	Motor overheating	A / N	Activated when the motor temperature exceeds the set limit
S7	Battery overheating	A / N	Activated when the battery temperature exceeds the set limit
S8	HW overcurrent	A / N	Activating internal HW current fuse (peak value)
S9	HW overvoltage / undervoltage	A / N	Activation if the input voltage drop below the critical limit or increase the voltage above the maximum allowed value **)

*) This information gives you a very good image about power reserve of your drive unit. Especially in constant speed mode (if you're on the limit or you have sufficient reserves), 100% is the maximum.

**) This information says that there was either a drop of traction voltage below the permitted limit of hardware, or to increase the voltage in over (above) permitted hardware limits, both for any reason. Measured are here immediate values, not averages.

Important - Alternative data:

If you will record a basic set of data (AUX1) or an alternate set (BEC) (i.e. data D4A up to D6A instead of data D4B + D6B), depending on the parameter P85 ("data-logger recorded values, basic values and:"). Choice must be entered into the controller before start record.

Data stored during recording to an external Black Box (module LBB_RT) (\$NA)

When connected to the controller module LBB_RT (external BlackBox and Real Time), all subsequent values, i.e. both standard Dxx as well as alternative Dxx-Ax. The recording time is limited only by used micro SD card.

Throttle limits setting

For correct controller reaction (by your image) is necessary unify throttle range (limits) of your transmitter with range throttle limits in your controller.

This setting (unify) is possible make by these ways:

- I. In the parameter P4 "Throttle limits" is set „Automatic" (default setting). In this case **controller DON'T REMEMBER throttle limits** and necessary learn real these values after each turn on of controller again. This case is description in details on the chapter „Start with automatic throttle limits".
- II. In the parameter P4 "Throttle limits" is set „Programmed". In this case **Controller REMEMBER throttle limits.** Necessary learn these real values once – this procedure is describe in the next paragraph „Programmed".
When you change the transmitter or the range of the throttle, or you change the receiver, you have to set the limits again.

Programmed:

Controller remembers throttle limits of your transmitter. Setting is possible make by these ways:

a) by program „Controller 2" and setting of your transmitter:

directly set values for neutral, max. throttle forward and max. throttle backward in these fields (or stay default values)

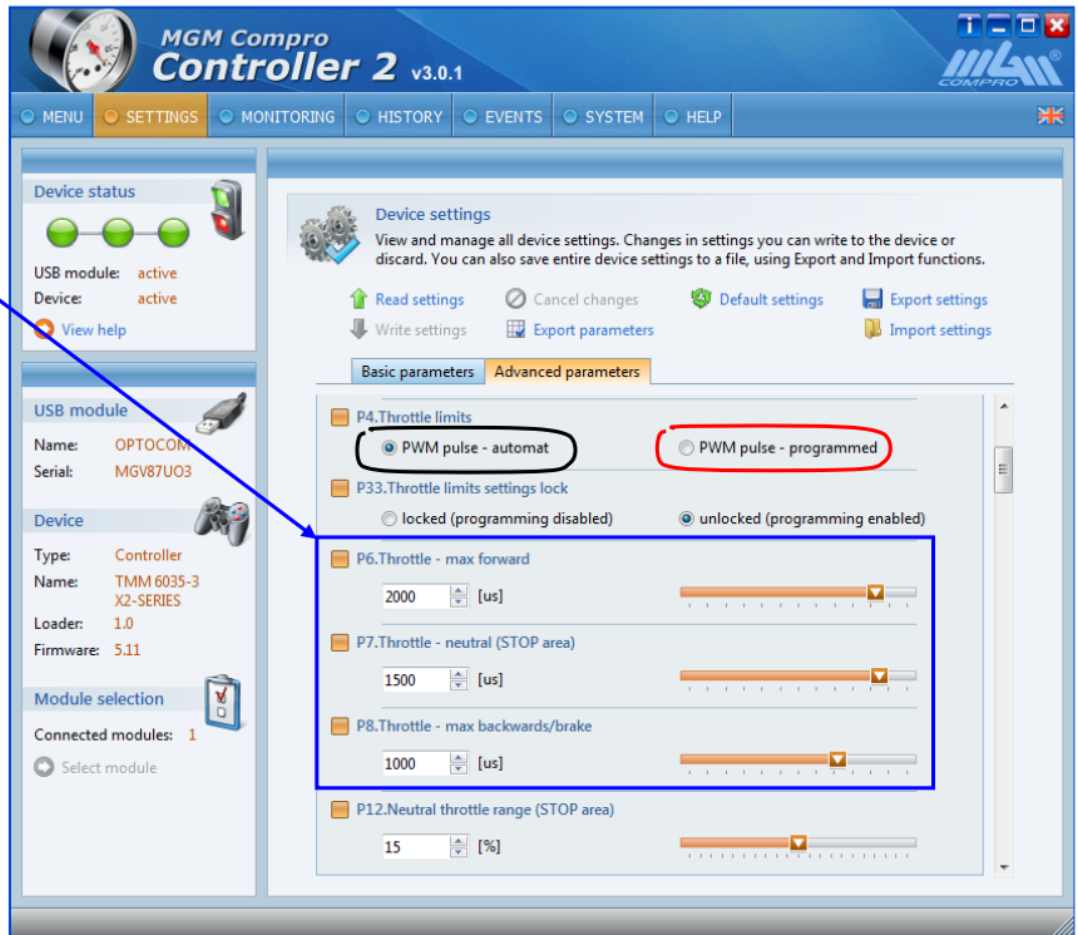

Subsequently is necessary set, by transmitter setting, position of the Neutral and max. deflections for forward and backward throttle position. Controller's LEDs indication significantly helps you with setting correct values in your transmitter.

Note: for transmitters without Neutral position set both values P7 and P8 to the same value (Throttle – neutral = Throttle – max.backward).

- 1) turn on transmitter with throttle stick on STOP (neutral) position, turn on receiver. Controller is connection to throttle channel.
- 2) turn on controller, wait for **blue LED** continuous light (not depend on other LEDs) ■ ■ ■ ■
- 3) change of Neutral position setting (STOP) in your transmitter that **yellow LED** also continuous light (not blinking) ■ ■ ■ ■
- 4) move throttle stick to full throttle forward and set your transmitter for continuous light (not blinking) of **green LED** ■ ■ ■ ■
- 5) when you have transmitter with neutral position, move throttle to max. throttle backward (max. brake) and set your ■ ■ ■ ■

Now in your transmitter are set the same throttle limits (deflections) as values in your controller.

For better orientation of marking that which throttle position, see to pictures in chapter "Basic operational modes".

b) by transmitter – preferred procedure. Corresponding values inside controller you set with transmitter help. Procedure is described in next chapter „Throttle limits setting by transmitter".

Correct throttle limits is possible set by this procedure whenever, without PC, after each transmitter change, change of throttle range of transmitter or receiver change. Necessary condition is setting of parameter P4 "Throttle limits" to "Programmed".

Throttle limits setting by transmitter:
 (parameter P33, "Throttle limits settings lock" must be set to "Allowed")

In the parameter P4 "Throttle limits" is set "Programmed".

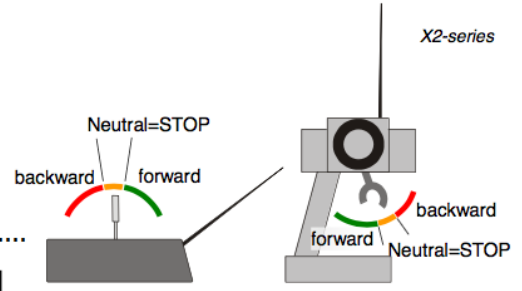

α) Transmitters with NEUTRAL (with lock of STOP position):

- 1) Turn on transmitter with throttle in position „full throttle forward“. Turn on receiver, controller connected to throttle channel of receiver.
- 2) Controller short beep 3× by motor, **blue LED** and **green LED** lights. After 10 seconds controller 3× long beeps.

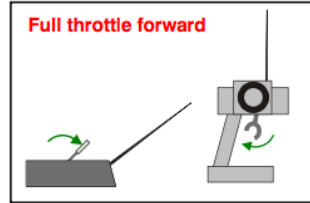

- 3) You now have **3 seconds** to move the throttle to max. throttle backwards (=full brake). *If in this time limit you do not move the throttle the programming process will finished and the controller will be turned off. Its next operation is possible after switching off and then turning it on again*

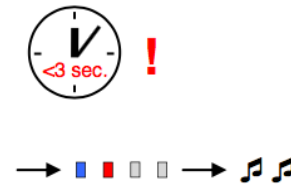
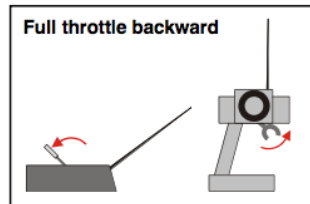

- 4) If you start moving throttle in this time limit 3 sec. to max. throttle backward position, controller lights **red LED** and after stop in outer position (max. throttle backward) 2× long beeps.

- 5) Controller lights **yellow LED** (challenge to moving to STOP position). You have now **3 second** for moving throttle to Neutral position (=STOP).

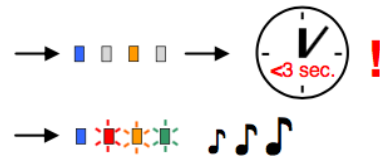
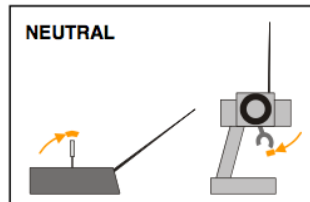

- 6) Controller confirm correct finishing of this operation by 1× blink together by **red LED**, **yellow LED** and **green LED** and play melody.

- 7) Controller starts blinking by **blue LED** (others LEDs not light) → necessary switch-off controller. Throttle limits of your controller corresponding with throttle limits of your transmitter and controller remember these values.

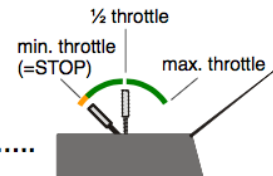

β) Transmitters without NEUTRAL (without lock of STOP position):

- 1) Turn on transmitter with throttle in position „full throttle“. Turn on receiver, controller connected to throttle channel of receiver.
- 2) Controller short beep 3× by motor, **blue LED** and **green LED** lights. After 10 seconds controller 3× long beeps.

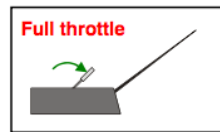

- 3) You now have **3 seconds** to move the throttle to min. throttle (=STOP) *If in this time limit you do not move the throttle the programming process will finished and the controller will be turned off. Its next operation is possible after switching off and then turning it on again.*

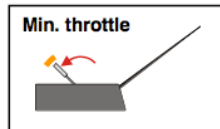

- 4) If you start moving throttle in this time limit 3 sec. to min. throttle position, controller lights **red LED** and after stop in outer position (min. throttle) 2× long beeps.

- 5) Controller lights **yellow LED** (challenge to moving to STOP position). You have now **3 second** for moving throttle to STOP position.

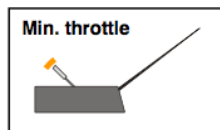

- 6) Controller confirm correct finishing of this operation by 1× blink together by **red LED**, **yellow LED**, **green LED** and play melody.

- 7) Controller starts blinking by **blue LED** (others LEDs not light) → necessary switch-off controller. Throttle limits of your controller corresponding with throttle limits of your transmitter and controller remember these values.



Start with automatic throttle limits

In the parameter P4 "Throttle limits" is set „Automatic“, this is also default setting.

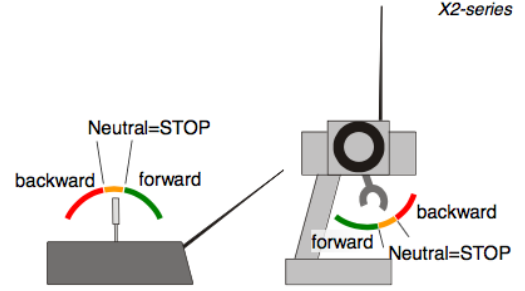

α) Transmitters with NEUTRAL (with lock of STOP position)

1) Turn on transmitter with throttle stick on STOP (neutral) position, turn on receiver. Controller is connection to throttle channel.

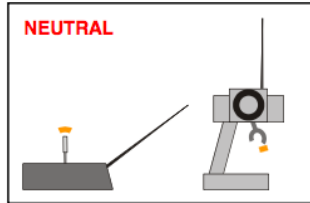

2) Turn on controller, wait for blue LED + yellow LED continuous lights + 1x short beep

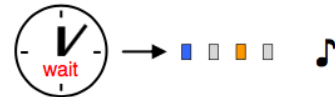

3) Controller alternately light yellow LED and green LED → challenge to moving throttle stick from "neutral" to "full throttle forward" position. After finishing of motion light green LED + 3x short beep

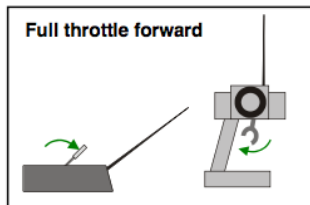

4) Controller alternately light green LED and red LED → challenge to moving throttle stick from "full throttle forward" position to "full throttle backward" position. After finishing of motion light red LED + 2x short beep.

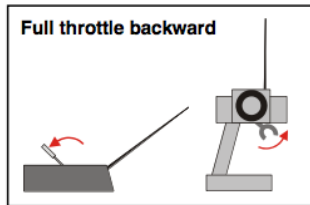

5) Controller alternately light red LED and yellow LED → challenge to moving throttle stick from "full throttle backward" position to "neutral" position. After finishing of motion light yellow LED + 2x short beep + play melody.

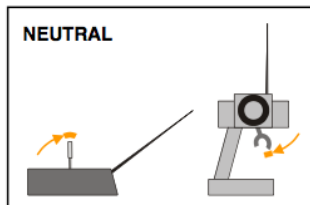

6) You can start now.

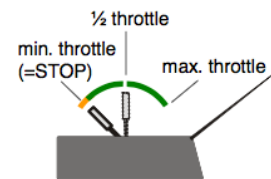

β) Transmitters without NEUTRAL (without lock of STOP position)

1) Turn on transmitter with throttle stick on Min. throttle position (STOP), turn on receiver. Controller is connection to throttle channel.

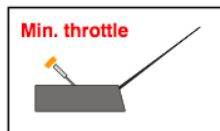

2) Turn on controller, wait for blue LED + yellow LED continuous lights + 1x short beep



3) Controller alternately light yellow LED and green LED → challenge to moving throttle stick from "neutral" to "full throttle forward" position. After finishing of motion light green LED + 3x short beep.

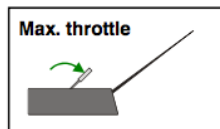

4) Controller alternately light green LED and red LED → challenge to moving throttle stick from "full throttle" position to "Min. throttle" position. After finishing of motion light red LED + 2x short beep

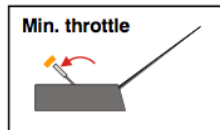

5) Stay on this position, min. throttle (STOP) at least 3 seconds controller light yellow LED + play melody

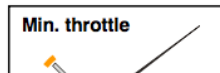

Start with **programmed** throttle limits

In the parameter **P4 "Throttle limits"** is set **"Programmed"**. Controller remembers set throttle limits.

- 1) Turn on transmitter with throttle stick on **STOP** (neutral) position, turn on receiver. Controller is connection to throttle channel.
 = **neutral** for transmitters with neutral
 = **min. throttle** for transmitters without neutral

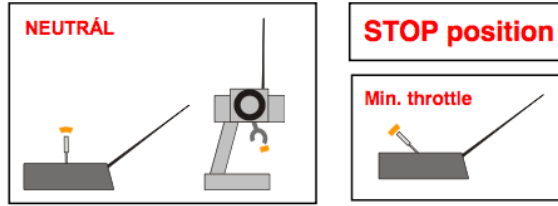

- 2) Turn on controller, wait for **blue LED + yellow LED** continuous lights + melody
- 3) You can start now.



Back data transfer, telemetry (only for controllers marking „BC“)

Controllers with „**BC**“ modification has not only general servocable #1, but also **servocable #2**. This cable transfer data from the controller to receiver (and receiver transfer these data subsequently to transmitter side). This **servocable #2** is connected to corresponding channel of receiver (for details see manual of receiver). Advantage is also boost of BEC wires – this cable transfer within data also BEC voltage to receiver → increase reliability as well as current rating of the BEC (smaller conduction losses on the wires and connectors).

Necessary set corresponding data format, in parameter „**telemetry**“ by program „**Controller 2**“ (as for example **TWIN** for receivers and RC equipment of **MZK servis** company, etc.)
 Display unit, which displayed transferred data, connect to transmitting module 2,4GHz of your transmitter.
 For connection and set receiver, transmitting module and display unit follow instruction for these components.

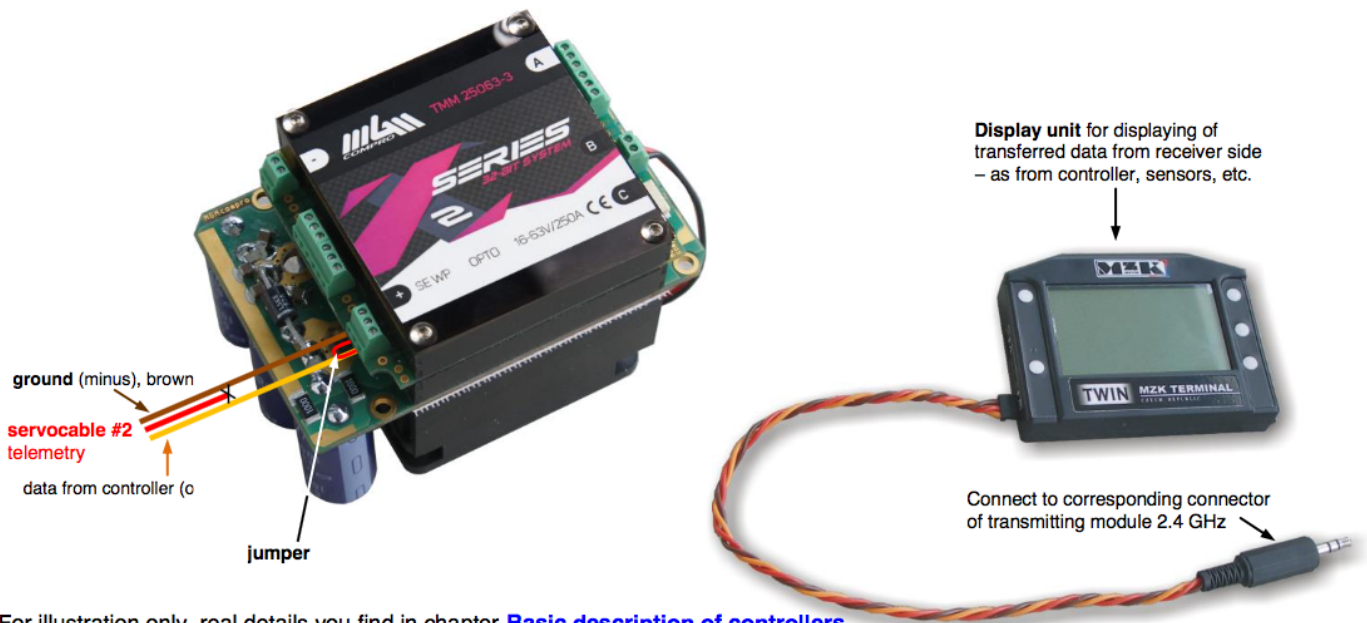

For illustration only, real details you find in chapter [Basic description of controllers](#)

Transferred data from the controller to display unit:

Into the transmitter are moved all the values stored in the internal BB ("[Data stored in the record](#)"), which data will be displayed depending on the display screen.

Sensor motors and controllers („SE“ marking)

Sensor motors (BLDC motors with sensors) can have, generally, various connectors for sensors. When your motor matches EFRA specification, situation is simpler.

When your motor has with EFRA specification connector or not or you are not 100% sure that sensor connector matches EFRA specifications or you are not sure which wires is „A“, which „B“ etc., necessary make „Automatic sensor setting“ first ! This means before any tests – first start with sensor motor must be make always in “Automatic sensor setting” mode ! Otherwise, risk destruction or damage of the controller.

Nevertheless, this (Automatic sensor setting) is very advantageous make in all cases, i.e. also for EFRA compatible motors – some of them have sensors not in optimal positions – and needless losses rise from this. **Automatic sensor setting** eliminates this imperfection and optimizes sensors setting also for these motors.

When you change motor, make this setting again.

IMPORTANT: When motor rotate to other side than you need, necessary change rotation direction ONLY by controller setting, in parameter P54, “Reversal of motor revolution”. No permit swap two motor wires (phases) as for sensorless motor !!!

In all cases is necessary observe all pin specification, as show in follow figure:

SENSOR MOTORS:
Sensor motor according to EFRA specification:

- must have 6-pin JST ZH connector model ZHR-6 or equivalent, marked as SZH-002TP0.5 26-28 awg. for sensors and heat sensor connection

Pins specification of this connector:

- Pin #1 – black wire, ground potential (minus)**
- Pin #2 – orange wire, sensor phase C**
- Pin #3 – white wire, sensor phase B**
- Pin #4 – green wire, sensor phase A**
- Pin #5 – blue wire, motor temperature sensing, 10 kΩ NTC**
 (other end of sensor is on ground potential, pin #1)
- Pin #6 – red wire, sensors feeding, +5.0 V ± 10%.**
 (supply voltage for sensors provide controller, don't connect external voltage !)

- power wires are marked A, B, C – connect to phases of controller, with the same name.
 A for phase A
 B for phase B
 C for phase C

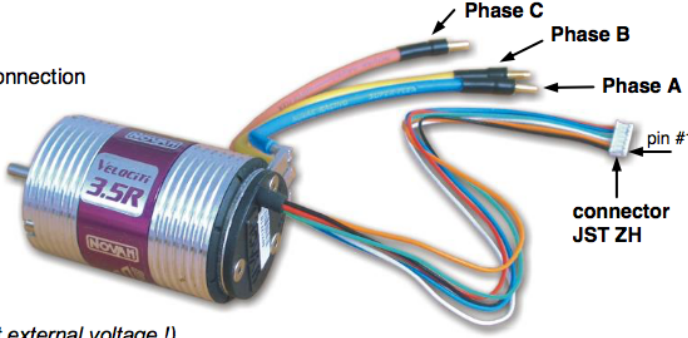



Example: Motor by NOVAK, Velocity 3.5R Brushless Motor

Sensor supply wires (pin #1 and pin #6) and temperature sensor wire (pin #5) no possible change ! Connection of Sensor outputs for phases (pin #2, pin #3, pin #4) aren't so strict – this can be connect in other order, providing that you make Automatic sensor setting first.

Automatic sensor setting procedure

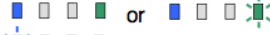
This setting is necessary make on the not loaded motor – i.e. without propeller or pinion for gear !

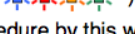
- 1) connect motor to controller, include sensor cable, connect to PC and turn on controller.
- 2) in program „**Controller 2**“ set parameter **P46, Motor type** to „**BLDC with sensors - learning mode**“
- 3) write this setting to controller by button „**Write setting**“
- 4) turn off controller (USBCOM 4 is possible disconnect)
- 5) turn on transmitter
- 6) when controller is not connected to receiver, connect now, to throttle channel (for OPTO version also turn on receiver supply)
- 7) turn on controller again, **if you don't set throttle limits (= you have automatic limits), must go through the initial setup limits procedure, i.e. until state of lighting blue LED and yellow LED** (throttle in Neutral position) 
- 8) move throttle stick to full throttle forward, controller start run motor and automatically stop 
- 9) LED indicate correct finishing of this operation by **blinking of blue LED** 
 (in case of some problem start **blinking all LEDs** )
- 10) if you don't see LEDs (controller is somewhere inside model) you can check correct finishing of this procedure by this way:
 move throttle stick back to STOP position and try increase throttle again → motor must not start run now
- 11) switch-off controller, sensors position and phase are correct and optimize, after correct finishing procedure controller automatically switch **Motor type** parameter to “**sensors**” – you can check this also by read data via program **Controller 2**.
- 12) when you turn on controller now, working with sensors – you can connect load to motor (propeller, pinion, ..)

Note: After correct finished procedure controller automatically switched parameter settings to “sensor motor“, you can check this via reading data from the controller by program „**Controller 2**“. This setting is remembered (up to next start of this procedure).

When procedure finishes not correctly, checks connectors, sensor connections, and start procedure again.

For Sensors connection details see chapter [Basic description of controllers](#) .

Settings the Maximal revolution of the system (of the helicopter rotor)

(For HELI mode #2 also 3rd throttle settings)

For setting of Maximal revolution of unloaded motor (view from the motor, not mechanics of the system) necessary make following steps:

Set these parameters values by program **Controller 2** (obligatory data):

- Parameter P50** – max. requested rpm limit (on the gear output), **RR**
Parameter P47 – number of motor poles **PP** (determined every correct motor producer or you can count magnets, see picture)
Parameter P48 – mechanical gear ratio **X:1** of gearbox, **G**

By these steps you have set maximal revolution. This settings is also revolution of 3rd throttle (flight mode =3) for HELI mode #2.

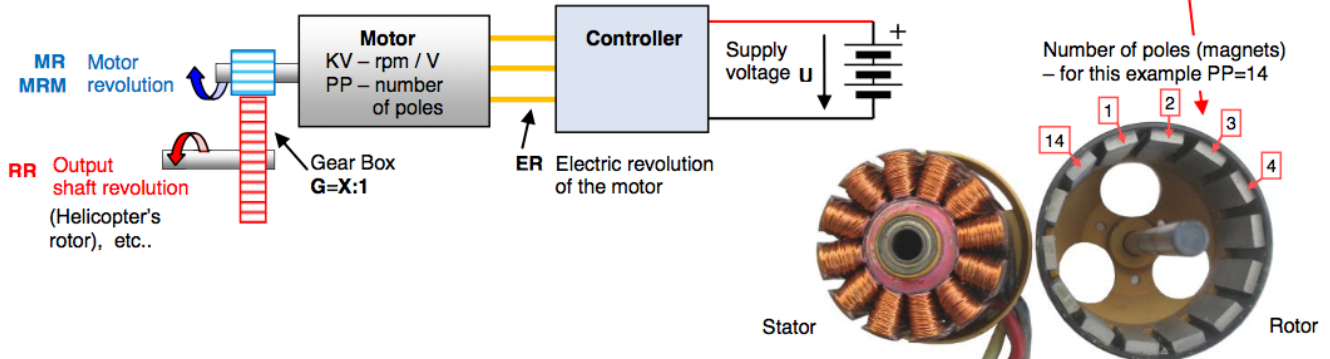

We recommend make checking, if controller range of rpm (electric) is sufficient as well as if motor choice is correct:

“Electric revolution” of the motor is the same as mechanical revolution only for 2-poles motor. Motors with higher number of poles have electric revolution (which must generate controller) proportionally higher (4 poles motor 2x, 6 poles motor 3x, etc.). Controller cannot work with higher revolution than specified in Technical data (for HBC controllers 250.000 rpm).

$$ER = RR \times G \times PP/2 \quad (\text{electric revolution})$$

where: **RR** – requested mechanical revolution on the output shaft (for example helicopter's rotor, etc.) [rpm / V]
G – gear ratio of gearbox
PP – number of poles of the motor

Result must be < 250.000 rpm. In case of result is higher value, necessary lower gear ratio or use motor with lower number of poles.

Example:

requested mechanical revolution on the output shaft **RR = 2.000 rpm**.
gear ratio is 10 tooth of pinion, 50 tooth of main shaft, i.e. **G = 50/10 = 5**
number of poles of the motor **P = 12**

$$ER = RR \times G \times PP/2 = 2000 \times 5 \times 12/2 = 60.000 \text{ rpm}$$

Result: therefore this value 60.000 < 250.000, controller is suitable for this system.

In next step necessary check motor, if requested output revolution is correct with available voltage.

Requested mechanical revolution of the motor:

$$MR = RR \times G$$

where: **RR** – requested mechanical revolution on the output shaft (for example helicopter's rotor) [rpm / V]
G – gear ratio of gearbox

We recommend this revolution no more than 70 - 80% of **max. available mechanical revolution of the unloaded motor (MRM)**. In other case not assurance that system has enough reserve of the power for reliable stabilization of the requested revolution.

Maximal available mechanical revolution of the unloaded motor:

$$MRM = KV \times U$$

where: **KV** – motor revolution [rpm / V]
U – supply voltage [V]

Example:

requested mechanical revolution on the output shaft **RR = 2.000 rpm**.
gear ratio is 10 tooth of pinion, 50 tooth of main shaft, i.e. **G = 50/10 = 5**
Motor **KV = 800 rpm/V**
Max. supply voltage: (6 x Lipol), i.e. **U = 25,2 V** (charged battery) / **U = 19,8 V** (discharged battery – last 20% of energy available)

$$MR = RR \times G = 2.000 \times 5 = 10.000 \text{ rpm}$$

$$MRM = KV \times U = 800 \times 25,2 = 20.160 \text{ rpm (charged battery)}$$

$$MRM = KV \times U = 800 \times 19,8 = 15.840 \text{ rpm (discharged battery)}$$

Result: Therefore requested (MM) 10.000 rpm is lower value than 70 - 80% of max. available revolution (=63%), motor is suitable for this system.

Maximal revolution of the motor Settings

If it is important to limit the engine speed (not the transmission system), you need set only:

Parameter P46 – max. requested rpm of the motor **MR**

HELI modes

Another, special indication for HELI modes:

- TOTAL STOP, turn-off.....
- Autorotation
- 1st throttle (revolution set by P73 parameter)
- 2nd throttle (revolution set by P74 parameter)
- 3rd throttle / Max. revolution (revolution set by P50 parameter)

IMPORTANT:

Current fuse as well as thermal fuse is disabled in heli modes ! – motor revolutions are not reduced, nor switched off – only indication (external circuit connect to ICS-2) is activated – it is necessary to land immediately. Circuits that watch the voltage of batteries also only activate indication of batteries getting discharged soon, motor revolutions are not reduced, nor is the motor switched off - it is necessary to land immediately. **It is very advantageous to use radio system with back transfer data and indications of important values for the pilot in real time.**

Before setting HELI modes is necessary first set **maximal revolution of the rotor** (parameter **P50**, see previous page), as well as parameters **P47**, **P48** and for heli mode #2 also parameters **P73** and **P74** !!! Don't remember to parameter **P69** (constant rpm).

To obtain smoother revolution settings, revolutions in the range of 50 to 100% of maximal requested revolution are "expand" through the whole throttle range (outside the area of autorotation and STOP).

A great advantage of modes with constant revolutions is that revolutions of the motor (or rotor) are held while change of load significantly better than it is possible to do so with throttle and pitch curves on transmitter, and constant revolutions are also held even when drop in voltage occurs (in case enough energy for motor).

Controller may be operates in HELI settings with these different modes:

- a) **HELI mode #1**, not stabilized revolution (P3= heli mode #1 + P69= direct motor PWM control)
- b) **HELI mode #1**, constant revolution (governor) (P3= heli mode #1 + P69= constant rpm of the motor)
- c) **HELI mode #2**, constant revolution (governor) (P3= heli mode #2 + P69= constant rpm of the motor)

a) HELI mode #1, not stabilized revolution

In this mode, the controller does not hold constant revolutions of the motor – instead, it behaves like aircraft controllers with the exception of fuses and signalization, which are set differently to better suit helicopters' needs. Motor together with controller behaves similarly to glue engine, also setting of transmitter is the same, which means that mix PITCH – THROTTLE (GAS) and their curves are set the same way as if flying with glue engine. Throttle (gas) channel must be assigned to controller (e.g. CH1 for mc-16/20, CH6 for mc-22, CH3 for FC-18, FC-22 etc.). Throttle curve must be set so that changes in revolutions with change of load would be as small as possible. However, changes in revolutions (decrease) when drop in voltage occurs cannot be compensated in the manner described above.

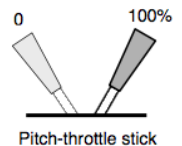

b) HELI mode #1, constant revolution (governor)

Controller must be assigned to any available (unoccupied) channel (e.g. CH5 for mc-16/20, FC-18), **which is not mixed with pitch !!!**

Throttle value control potentiometer, of that channel is used to easily set constant revolutions that you desire in the range 50 up to 100% of programmed maximum, parameter **P50**, see previous page „Maximal revolution of rotor settings“, according to the sound, or revolutions meter, etc. Revolution is linear depend on driving signal (throttle position). **Constant revolution can be easy change during flight by your current demand** - just set new desired revolutions using the move throttle stick to new position. As soon as you stop moving the throttle stick, the desired revolutions will be saved immediately and hold afterwards. It is quite similar to a cruise control in car. Constant revolutions are indicated by external LED (continuous light).

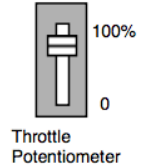

Next possibility is flight mode switch. Necessary assign to each position of the switch (or more switches) concrete values of driving signal (=requested revolution) on your transmitter – on the next picture are assign for values 1, 2 and 3 (in ring) concrete revolution (example). Switchover of the switch during flight change revolution to new requested by predefined values (inside the transmitter !).

Number of that's how predefined revolutions are not limited by controller, depend only on the transmitter possibility (and his possibilities of switch(es) configuration).

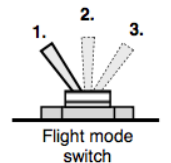

Throttle positions (flight modes) are indicate by controller's LED.

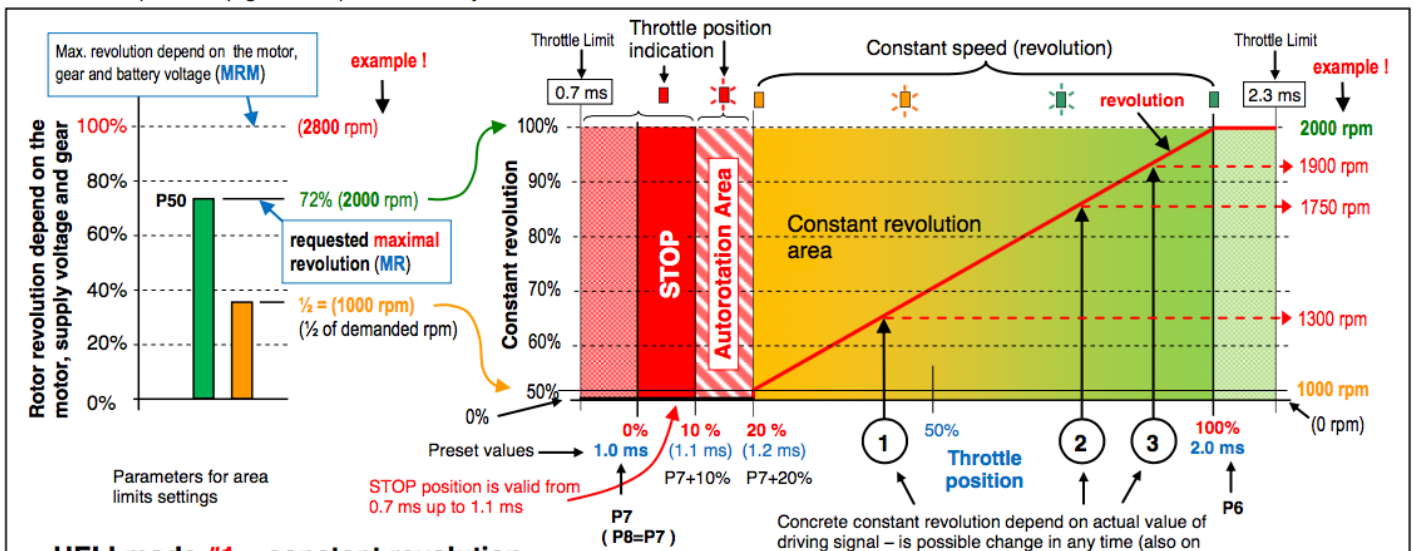

c) HELI mode #2, constant revolution (governor)

Controller must be assigned to any available (unoccupied) channel (e.g. CH5 for mc-16/20, FC-18), **which is not mixed with pitch !!!**

Throttle value control potentiometer. Constant revolution for flight modes $\equiv 1$, $\equiv 2$ and $\equiv 3$ (i.e. 1st throttle, 2nd throttle and 3rd throttle) are preset in the controller (**value in parameters P73, P74 and P50**). Controller set revolution according to throttle position inside corresponding area limits. **Preset values** (parameters P73, P74, P50) **are not possible change during flight**. Constant revolutions are indicated by external LED (continuous light).

Next possibility is flight mode switch. Necessary assign to each position of the switch (or more switches) concrete values of driving signal (=requested revolution) on your transmitter – on the next picture are assign for values 1, 2 and 3 (in ring) concrete revolution (example). That means, for example, for flight mode $\equiv 2$ (2nd throttle) can be driving signal (=throttle position) anywhere between 1,46 ms and 1,78 ms and revolution as always hold on the value preset in parameter P74. Etc. Switchover of the switch during flight change revolution to new requested by predefined values (**inside the controller !**).

Number of that's how predefined revolutions are limited to 3 values.

Throttle positions (flight modes) are indicate by controller's LED.

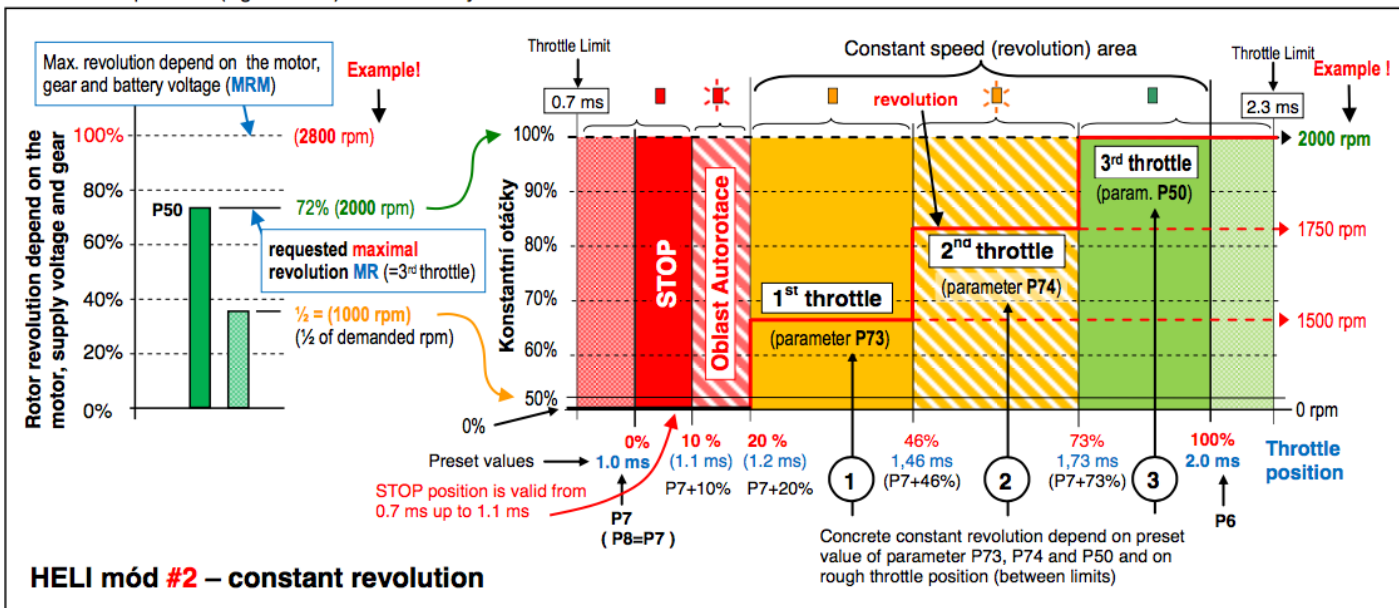
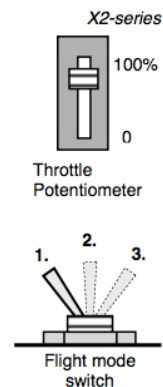

HELI mód #2 – constant revolution

Area limits are predefined. If acceptable for you, you needn't change this. If these predefined values are not optimal for you, you can change it in corresponding parameters P6, P7. When you change it (from any occasion), area limits for 2nd throttle automatically conforms.

Autorotation:

In all described HELI modes is available also special mode „Autorotation“. The Startup of motor from this throttle position is significantly quicker (rotor is always running) and is set in parameter P16 (acceleration). This mode is available by throttle moving as well as by switch „Autorotation“ (necessary assign to „ON“ position of this switch corresponding driving signal between cc 1.1ms and 1.2 ms). These values 1.1 and 1.2 ms is possible change indirectly by parameters P7 and P6 (always P7 + 10% and P7 + 20%, P6 defined 100% limit). This state (this mode) is indicate by **blinking of red LED**.

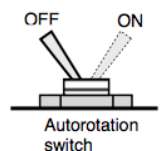

STOP position:

The Startup of motor from this throttle position (STOP) is significantly slower, depend of high centrifugal mass of the rotor and is set in parameter P17 (acceleration from STOP).

Flight mode switch enable choice one of two or three preset values of the rotor revolution. In some manuals marking:

- NORMAL** – IDLE UP1 – IDLE UP2 – IDLE UP3 (Robbe - Futaba)
- PHASE 1** – PHASE 2 – PHASE 3 – PHASE 4 (Graupner jr)
- STOP** – 1. throttle – 2. throttle – 3. throttle (Czech terminology)

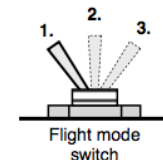

First position of this switch, mostly 0%, enable acceptance of throttle driving in full range 0% up to +100% by throttle stick

The **Startup** of motor from position 0 (rotor is not turning) is slow so that mechanical parts of helicopter are not exceedingly stressed by big inertial mass. On the other hand, start up from autorotation position is fast – when practicing autorotation there is no time for slow start up, moreover the rotor is already turning.

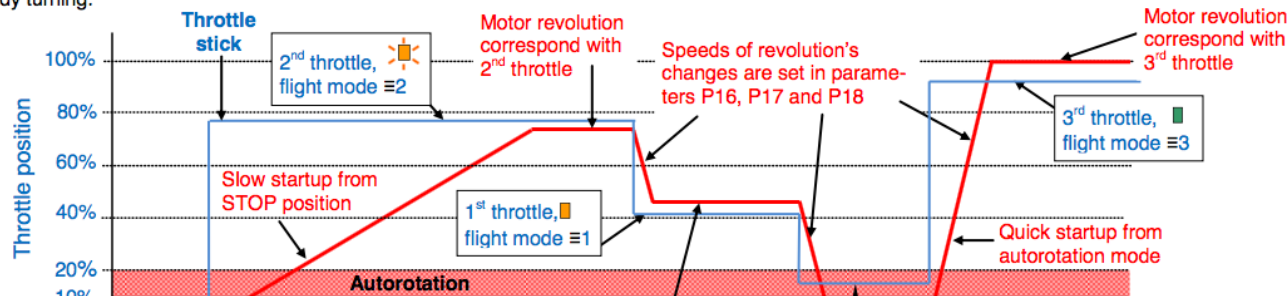

Technical data (valid for 25°C environment temperature)

Temperature of the environment:	0°C to 40°C	Number of regulation steps:	2048 / full throttle range
Motor controlling:	PWM: from 8 up to 32 kHz	Max. rpm for 2 poles motor:	250 000 rpm
Suitable for motors:	2 to 40 pole motors of classical conception (rotor inside) and also for outrunners (rotor is on the outer side) (sensors + sensorless) FreeAir, Hacker, Kontronik, Lehner, Mega AC, Model Motors, MP JET, MVVS, Neu, PJS, Plettenberg, Überall model, etc.		
Control signal:	Positive pulses 1.5 ± 0,8 ms, period 3 up to 30 ms		
BEC / OPTO :	controllers are OPTO versions and haven't BEC !!!		
Feeding:	only from batteries: NiCd, NiMH, Li-Ion, Li-Pol, A123, acid (Pb) or others cells (using of power supplies and DC/DC converters are prohibited !)		
Servocables:	with JR gold connectors, 0.25mm ²		

X2-SERIES TMM® xxxx-3	25063-3	40063-3
Maximal continuous power:	15,75 kW	25,20 kW
Basic dimensions see pictures [mm]:	see pictures with dimension	see pictures with dimension
Weight without power cables:	250 g	390 g
Weight with power cables:	depend on cables cross section and length	
Feeding voltage:	15 – 63 V	15 – 63 V
No. of feeding cells NiCd / NiMH:	15 – 44	15 – 44
No. of feeding cells Li-Ion / Li-Pol:	4 – 15	4 – 15
No. of feeding cells A123:	5 – 17	5 – 17
Max. continuous current:	250 A	400 A
Peak current for max. 5 seconds:	360 A	500 A
On-state FET resistance at 25 °C:	2×0,8 mΩ	2×0,53 mΩ
Possible modification:	OPTO	OPTO
Possible BEC version:	--	--
Cables cross section to batt. ■ / motor ■■■ *):	6/6 nebo 10/10 mm ² 10/10, 16/16 or 25/25 mm ²	

The appearance and the technical data may be changed without prior notice.

Recommendations: If you use controller for currents higher than ca half of the maximal values, we do recommend intensive cooling by air flow or use of heat sinks (possibly also active cooling using fans or water cooling for boats). This will not only prevent possible over-heating of the controller, but you will also gain higher efficiency of the drive unit (cooler controller has lower losses than warm one).

Maximal continuous (nominal) current:

Maximal continuous current (=current from the battery) is defined as current with full switching (100% motor PWM) with environment temperature 25°C and with corresponding cooling (air flow, fan or water cooling). Feeding from the battery with capacity 2 – 6Ah. This current is shown in the records (History) as "Input current".

Phase current:

Another important criterion is the phase currents in the full switch (=100% motor PWM). Requested are practically identical (as relates to the current value) as the current from the battery. If the phase current is significantly higher than the current from the battery (engine overloaded, poorly designed engine, etc.), the maximum continuous current will be proportionally lower. This current is shown in the records (History) as "Peak current".

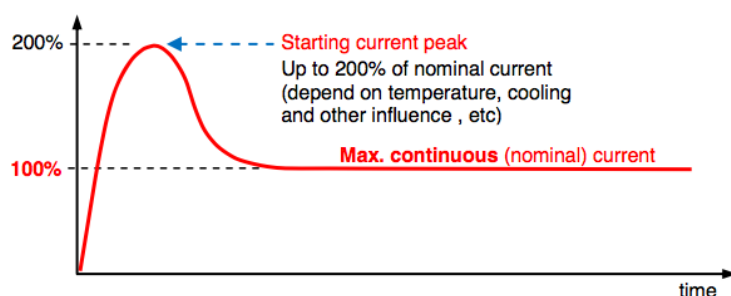
**Starting current peak:**

The controller tolerated for short periods up to about 2-3 seconds starting current peak, which can reach up to about twice the nominal current of the controller.

Influence of the battery quality to controller behavior (automatic current limiting).

If the current peak during loads the battery to such an extent that their voltage is about to drop below ca 12V (all versions 63V), there automatically is lowered the speed (power) of the onset of revolutions so that voltage does not drop under this limit.

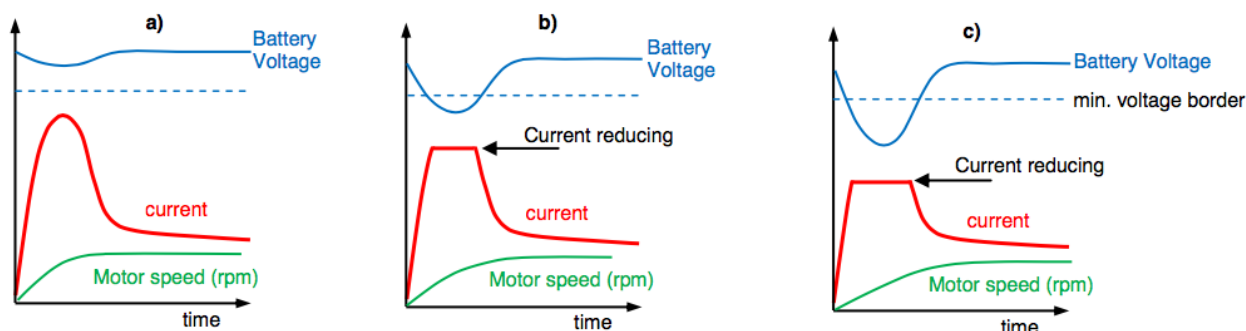

- a) Very quality („hard“) battery, voltage drop is low under load, not start current reduce process
 b) Not so “hard“ battery (worse quality) or too high load or too short acceleration time – current is reducing during acceleration so that voltage not dropped under minimum voltage border.
 c) Not suitable battery, damaged battery, extremely high load or extremely short acceleration time – current is significantly reducing for hold battery voltage above minimal voltage border.

ATTENTION: Danger of damage or destroy of the controller at risk:

- connecting more battery cells (higher voltage) to the controller than the maximum number specified in the technical data
- connecting battery voltage with reversed polarity
- short circuit wires to the motor when the battery is connected,
- confusion (swapping) of wires to the motor and the battery
- overload the BEC by higher currents or power losses than is specified in the technical data
- wetting or penetration of water into the controller (exclude WR), intrusion metal (conductive) objects to the controller
- controller feeding from a different source than specified batteries
- disconnecting the controller from batteries or switch off or disconnect the motor when the motor is still turning

Optional Accessories

You can specify all these options by your requests in order:

Switch (s):	all controllers may be ordered with a switch (in a safe design - its damage or destroy does not affect the safety of flight and the model)
Fans:	In case of insufficient cooling air flow it is possible to use heat sinks with fans FAN-12-60 or FAN-12-50 (depend o type of ESC), which significantly improve the cooling efficiency – active cooling .
Water cooling:	version with water coolers is available for use in boats.
Hydro version WP:	water and humidity does not get on well with electronics. For significant increase of durability of the controller against humidity and water, it is optionally possible to apply specialty protective cover (marked as WP). This however does not mean that the controller with this protection is 100% durable during humidity and water and that it is not necessary to protect it against these negative effects. The protection does not apply to salt water at all !
Hydro version WR:	If you need 100% protection against water, dirt, humidity, necessary choice WR modification. Plates with electronics components are fully sealed in special matter, more expensive version. No possible repair ! The protection does not apply to salt water at all ! For more information see manual “Water protection of RC equipment”.
Sensor motors SE:	all types of controllers may be ordered as „Sensor“ – marked as SE . These controllers may be connected to sensorless motors as well as sensor motors. In case of sensor motors, types compatible with EFRA are recommended. (EFRA Handbook 2007), e.g. motors „ Velocity x.R Brushless Motor “ by Novak, etc., more see here ».
Back data channel BC:	all types of controllers may be ordered as version with telemetry, with additional servocable for connecting to “back data channel” of receiver some of 2,4 GHz RC equipment, marking BC .
Battery temperature BT:	to OPTO controllers' version can be added measuring of the battery temperature
Battery each cell measuring EC:	controllers X2-series 40063-3 is possible order with connector „ SC “ (K4+K5) for direct measuring of each cell, incl. measuring of the battery temperature.

Controllers marking

Marking: TMM pppnn-3s / SE / BC / EC / WP / WR / / BEC / HV BEC / OPTO	where „ppp“ means current (2 – 3 digits), „nn“ gives voltage (2 digits), „s“ version with switch BEC / HV BEC / OPTO specify version with S-BEC, HV-BEC or without BEC, optically isolated „SE“ version for sensor motor, „BC“ version with telemetry, „EC“ each cells measuring „WP“ higher durability against humidity and water, „WR“ 100% durability against water, dirt, ...
Example: X2-series TMM 25063-3 / WR	250A, 63V, without switch, sensorless motor only, without telemetry, optically isolated, 100% water resistivity

Available versions of X2-SERIES controllers + dimensions

X2-series 25063 with a fan, enclosed version
view from the side with a fan
 (default dimensions)

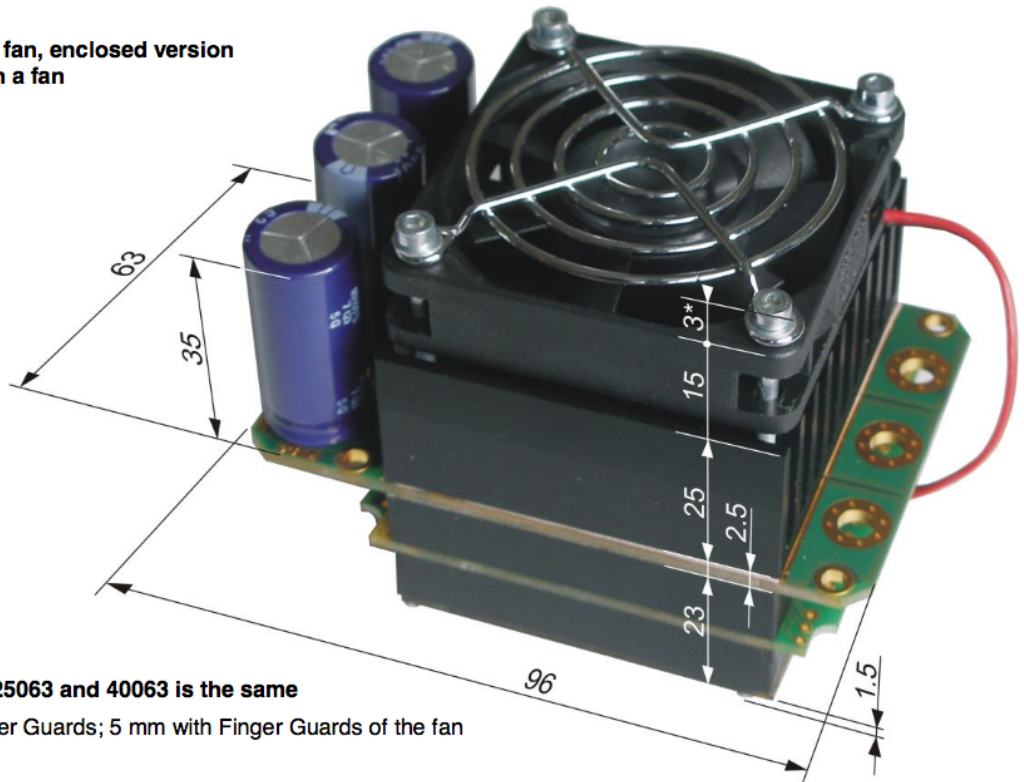

Height profile X2-series 25063 and 40063 is the same

*) dimensions without Finger Guards; 5 mm with Finger Guards of the fan

X2-series 25063, without fan, (without box here), filter capacitors axially,
 (this modification only by special requests)
View from the side of the control board:
 (default dimensions)

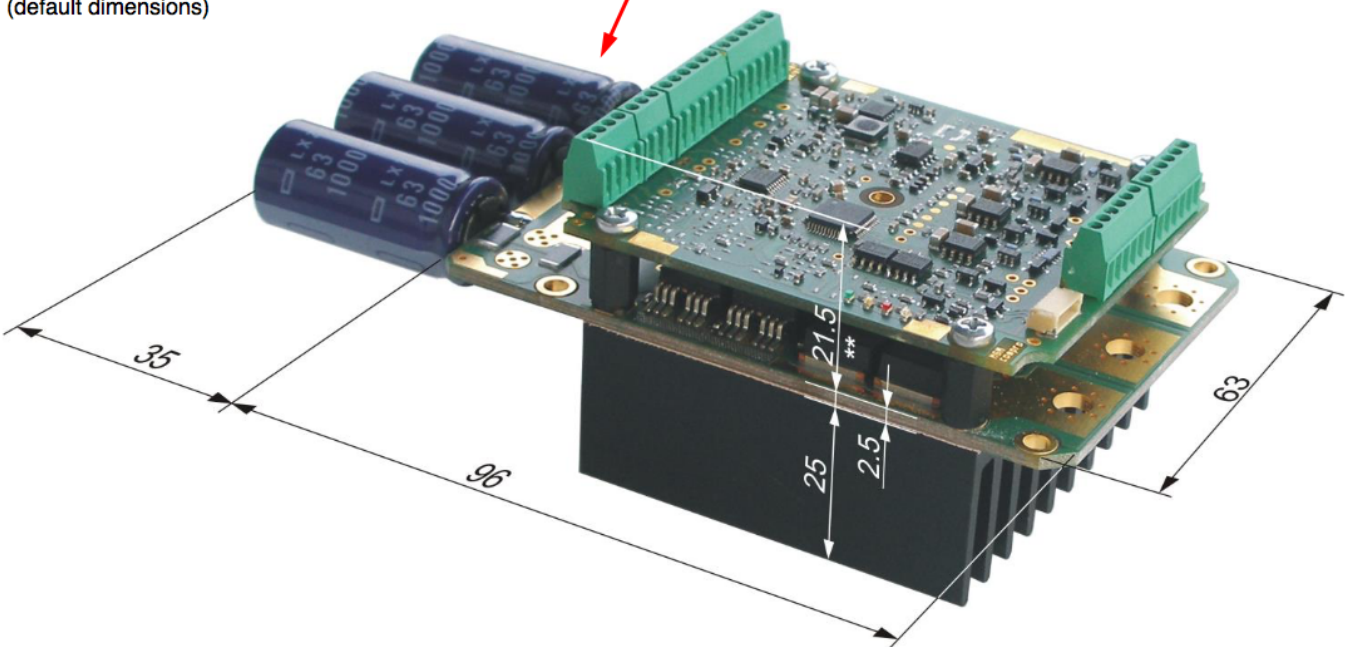

X-series 25063-3, side view on cooler without fan
(default dimensions)

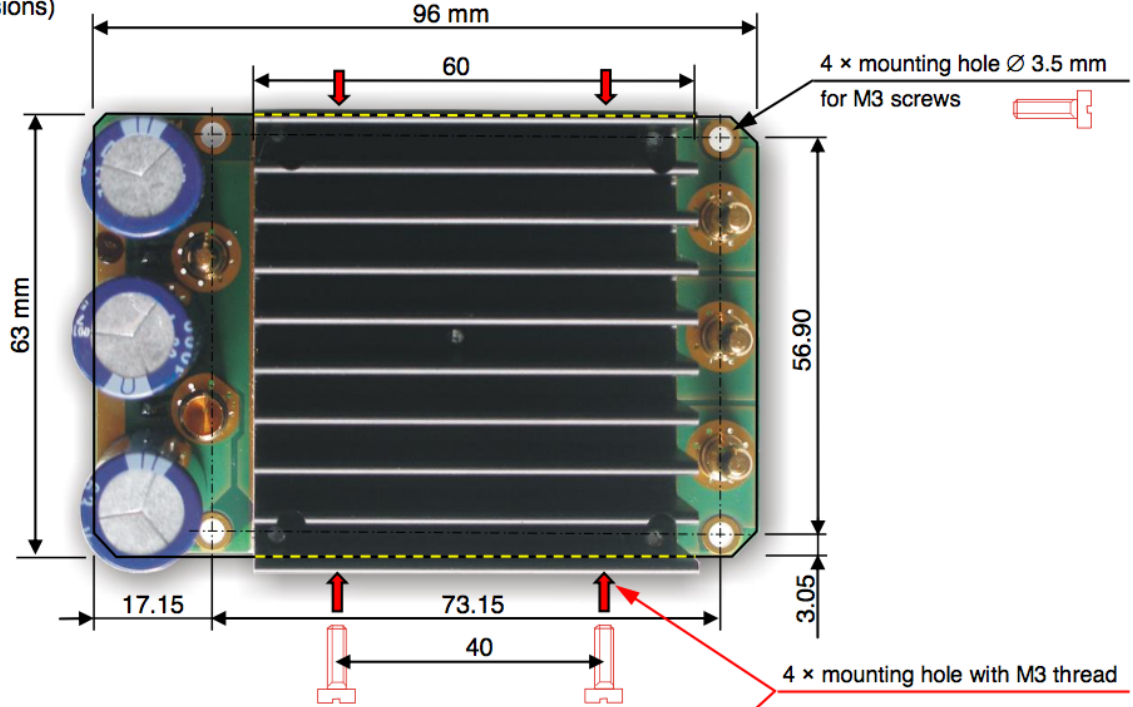

X2-series 40063-3, view from side of cooler with fans
(default dimensions)

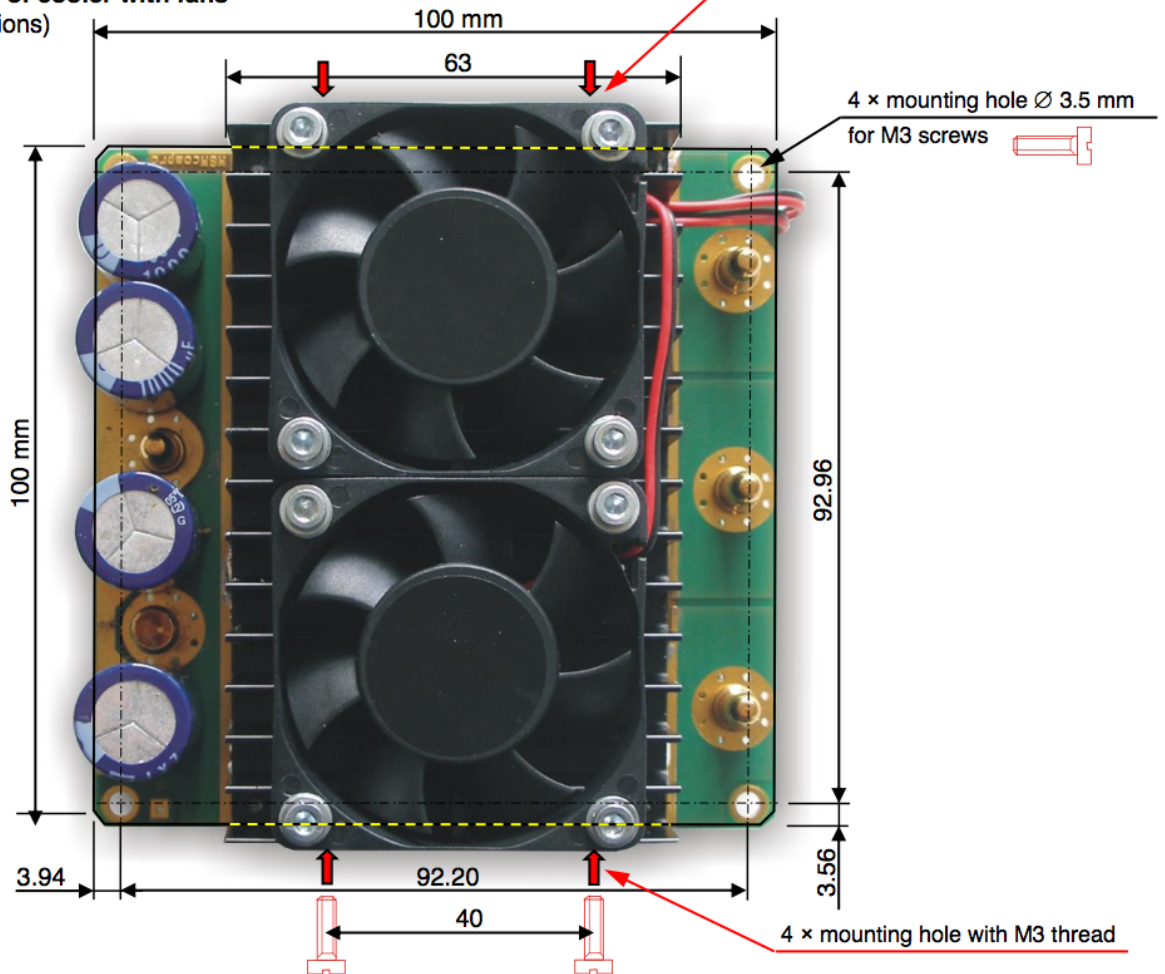

Mounting:

Mounting of controllers is possible using either the 4 mounting holes in the corner of the main PCB or using 2 / 4 screws M3 in the cooler (red arrows) from both sides (M3 screws are needed).
 If you use the holes in the main PCB, use spacer plate from non-conducting material (polyamide, xxxx etc). Choose the M3 screw head such that it is not in contact with the surrounding copper areas on the board (that is up to Ø 6mm) or use an insulating pad.
 If you use holes in the cooler, it does not matter which material is used as the coolers are insulated, they are not connected to any...

Basic types and modifications (valid for 250A and 400A version, however on the pictures are only one version):

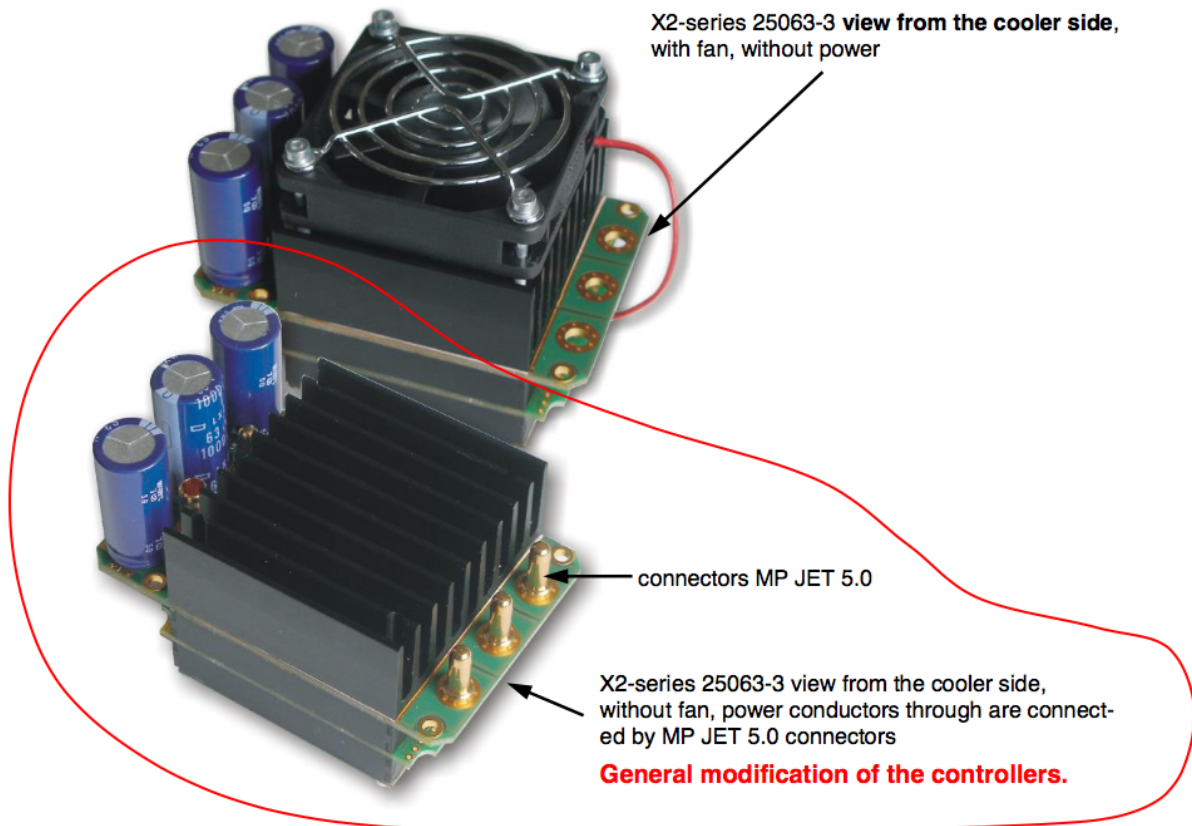

Power cables can also be connected to ring terminals or can be soldered directly to the controller:

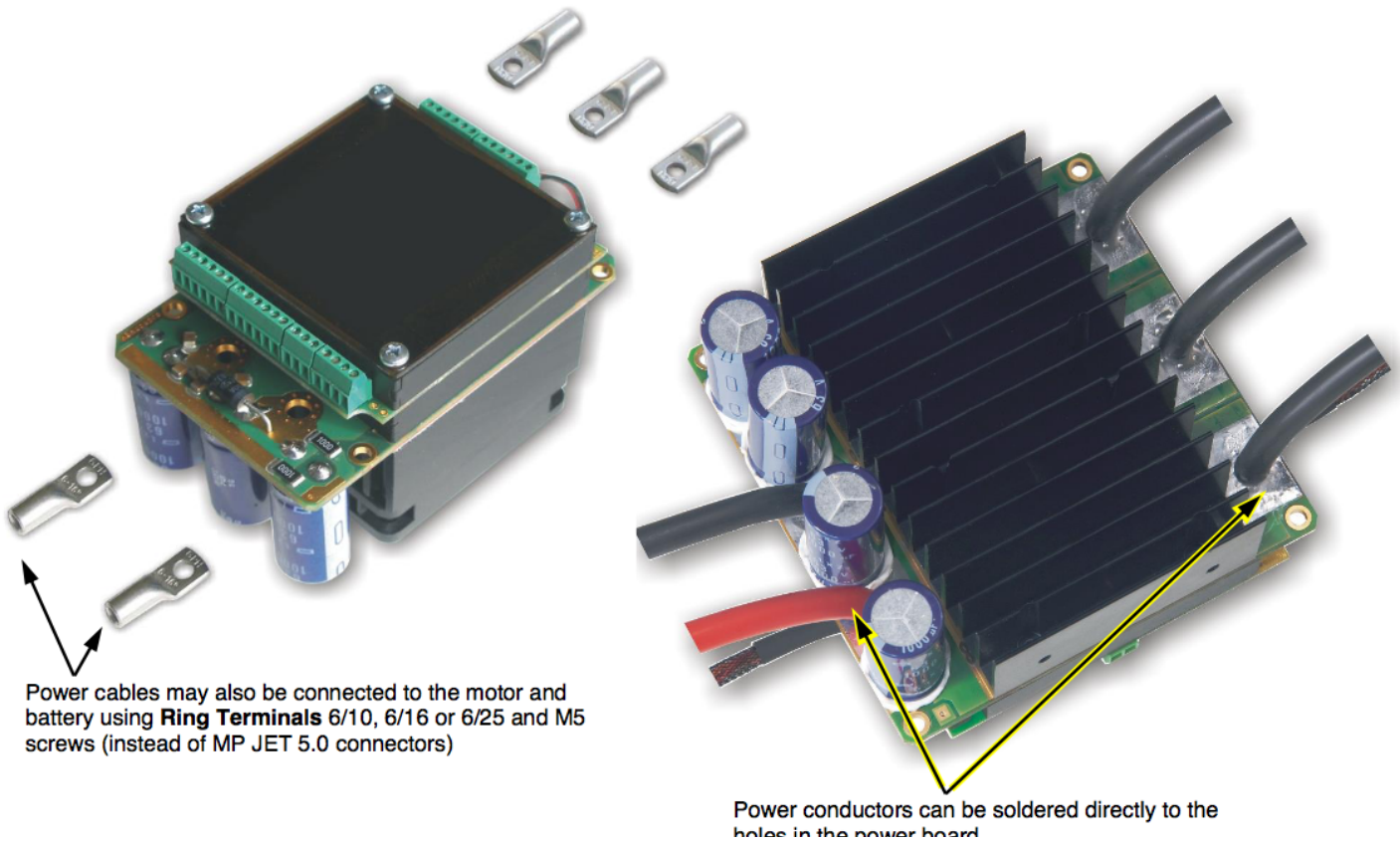

Water cooling for X2-SERIES 25063 and 40063:

X2-series 40063-3 view from the water cooler side, power cables are soldered directly to power board, filtering capacitors axially

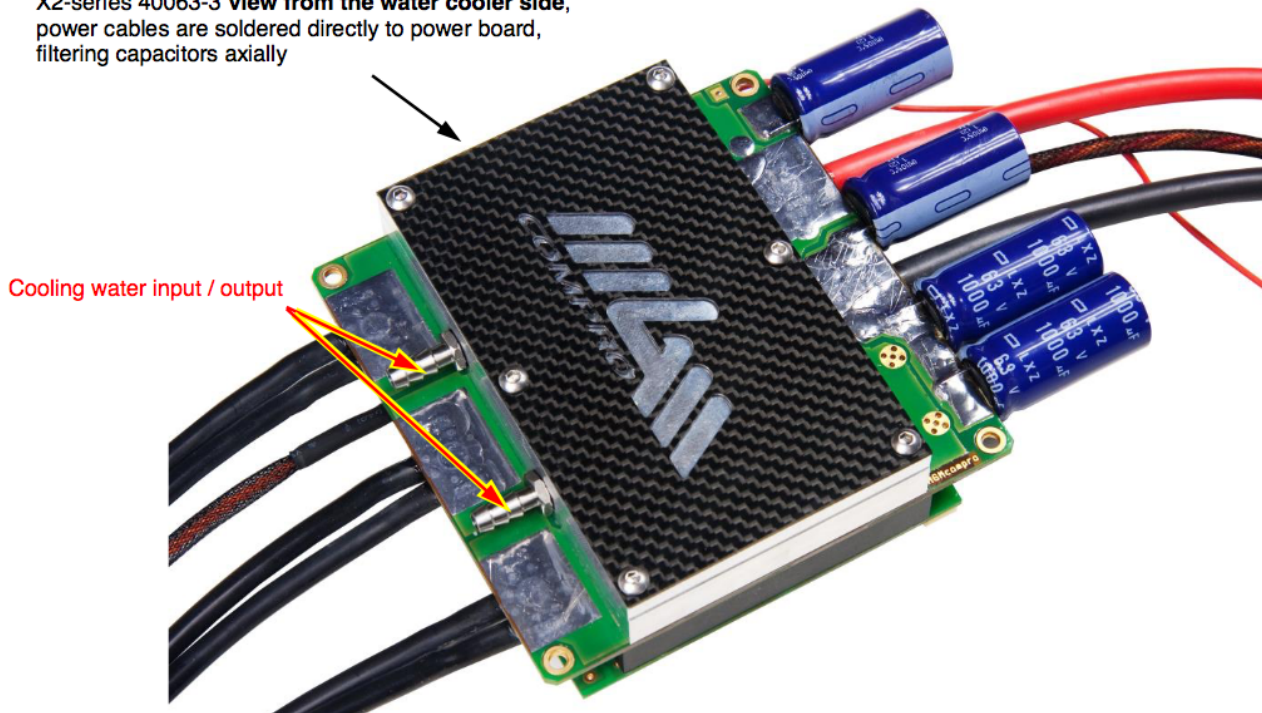

X2-series 25063-3 view from the water cooler side, power cables are soldered directly to power board, filtering capacitors axially

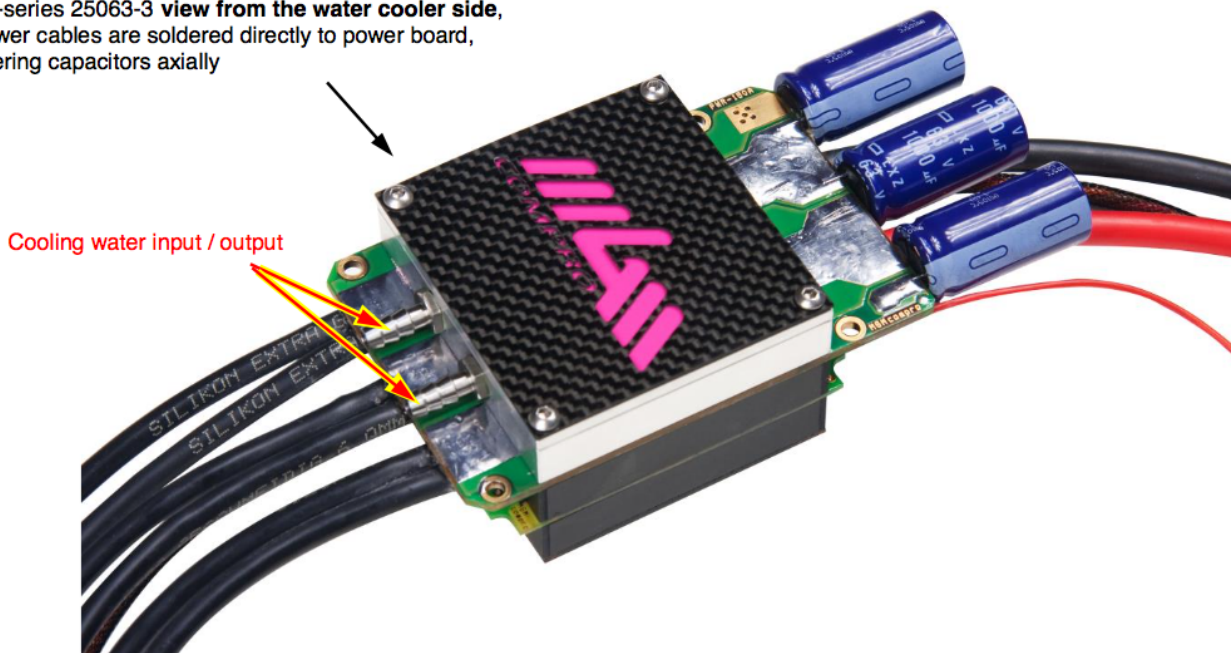

Controller states indication and Error messages

(firmware 5.0x and higher)

Controller indicate states by 4 LED and also acoustic by motor beeping.

short beep long beeeeep melody

In this example blue LED blinking, others lights continuously: / blue is light, other is off:

Possible states:

short blink of all LEDs after switch/on controller (check of LED)

a) correct states (= blue LED lights continuously):

- 1 - all is O.K., Controller communicate with the PC
- 2 - all is O.K., but controller without driving signal (all lost driving signal) ...
- 3 - throttle position STOP (neutral)
- 4 - signal is **above neutral position**, controller wait for Neutral.....
- 5 - signal is **bellow neutral position**, controller wait for Neutral.....
- 6 - partial throttle forward
- 7 - full throttle forward (full power).....
- 8 - partial brake when run forward
- 9 - full brake when run forward
- 10 - partial throttle backward
- 11 - full throttle backward (full power).....
- 12 - partial brake when run backward
- 13 - full brake when run backward

- 14 - **move** throttle from neutral to max. forward..... LED flash alternately
- 15 - **move** throttle from max. forward to max. backward..... LED flash alternately
- 16 - **move** throttle from max. backward to neutral LED flash alternately
- 17 - operation is in progress mostly just blinks 1×
(Automatic sensor adjustment, set up rotor speed, setting limits according to the transmitter,)

When happen some of next states (problems), correct states are not indicated. These not correct states indicated some problem in the system. These states last until switch-off (also its combination).

b) limit operational states (=blue LED not lights):

- 20 - power is reduced by high controller temperature.....
- 21 - motor is switch off by high controller temperature.....
- 22 - power is reduced by battery low voltage
- 23 - motor is switch off by battery low voltage
- 24 - power is reduced by high current peaks
- 25 - braking is reduced by high battery internal resistance

c) critical and error states (=blue LED blinking + some other LED):

- 30 - motor overheating
- 31 - destroy or damaged motor, sensors problem for SE version LED flash at the same time
- 32 - battery overheating.....
- 33 - *free (not used)* LED flash at the same time
- 34 - *free (not used)*.....
- 35 - current overload LED flash at the same time
- 36 - **damaged HW, call service** LED flash at the same time

d) special states

- 40 - **RESET state (=only blue LED blinking)** controller is necessary **turn off and on again**, this is required for some settings
- 41 **unfinished firmware update (=Blue light is very weak)** procedure "Firmware Update" must be repeated
- 42 - **supply voltage lost or with bad value **)** or some problem in HW
- 43 - **supply voltage is higher than the allowed limit !**

Sparking prevent when connect higher voltage

When connecting a Li-xxx pack with more cells to the controller, strong sparking commonly occurs. Fast charging of the controller filter capacitors causes this. The spark is more intensive for higher voltage (the higher cell count), the lower the internal resistance (and the better quality of the cells). The better the capacitors in the controller and the higher the capacity of the capacitors, the bigger spark occurs. Besides the small shock (due to the sparking), the charging current of the capacitors may be in, extreme cases, so great that damage or destruction of the capacitors occurs.

A simple procedure exists to eliminate sparking when connecting the battery pack. This inexpensive modification eliminates sparking and thus protects the filter capacitors.

Important: These two types of controllers have internal antispark resistor (inside controller). You can only connect wire to connection point (see page 7 and 8), without external resistor, and follow these instructions below.

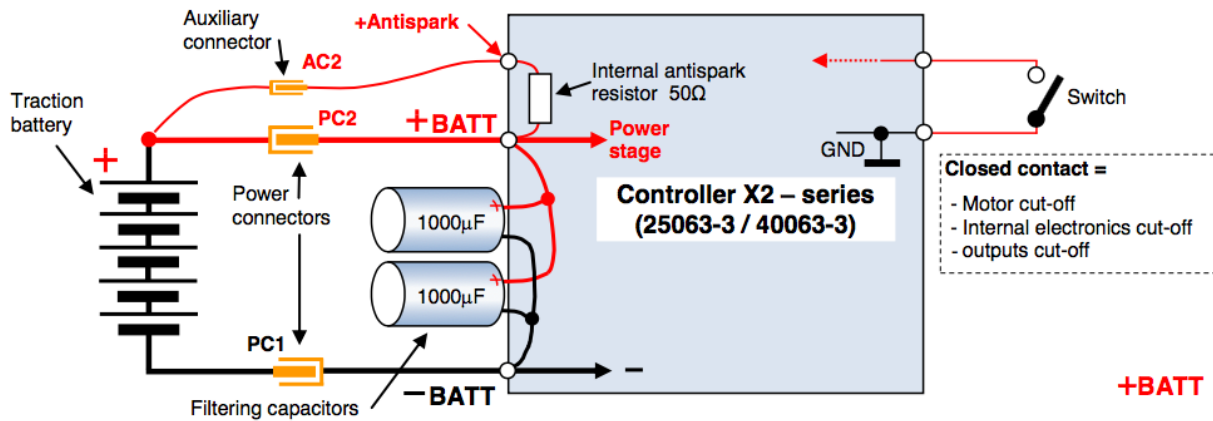

How to connect the battery:

- 1) connect the "-" leg of the battery to the "- BATT" terminal on the controller (PC1 connector).
- 2) in the positive supply branches connect first "+" battery terminal to the "+ Antispark" controller point by auxiliary connector AC2, which has included a series resistor of tens of ohms (resistor is integrated in the controller). This resistor will limit the charging current after connecting and charges the filter capacitors practically without sparks.
- 3) Now connect the "+" battery terminal to terminal "+ BATT" by force connector PC2 (already without any the sparks). The main current to the controller and motor flows by these heavy-duty connectors (PC1 and PC2) and conductors.

Note: There are no special requirements on the auxiliary connector AC2. The current is small (1- 2A) and lasts only for a short time.

If you use a additional capacitors block 10x1G0.63 (due to long wires, etc.), you must use an external antispark resistor for higher load. Resistance must be appropriately performance-rated - meets types for load 5 - 10W.

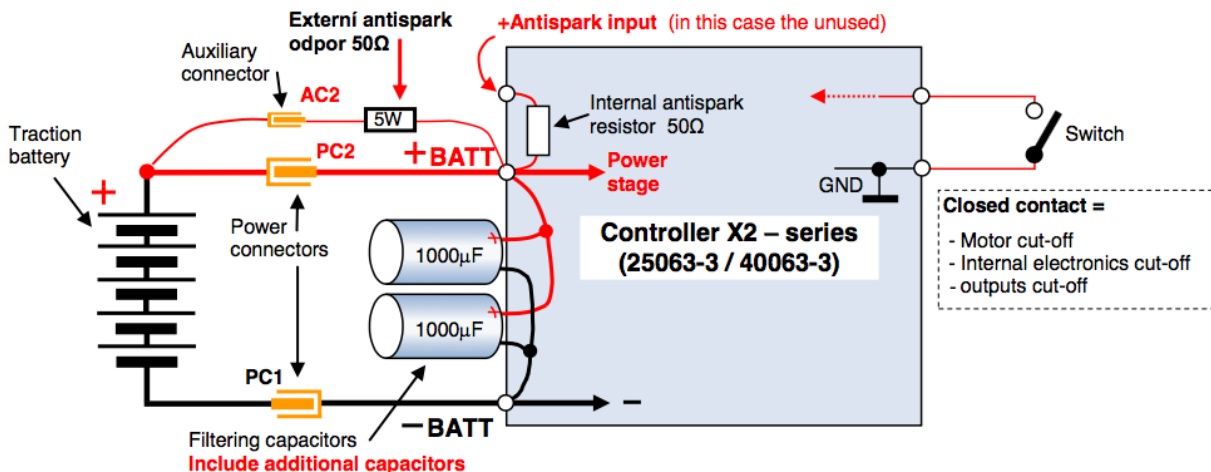

Postup připojování baterie k regulátoru: stejný jako v předchozím případě.

Jedno z možných řešení (zde pro názornost jsou spoje a konektory bez izolace):

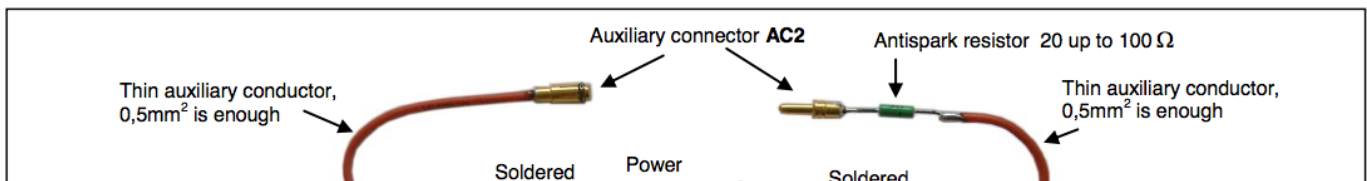

Feeding an external BEC from the traction battery

Important: If you use an external BEC powered from traction battery, **do not connect it to the controller to the terminal "+BATT" if you use the internal resistor antispark.** The current flowing through antispark to BEC through AC2 connector, in the moment when it is not connected to power connector PC2, can antispark internal resistor overload and destroy.

WRONG

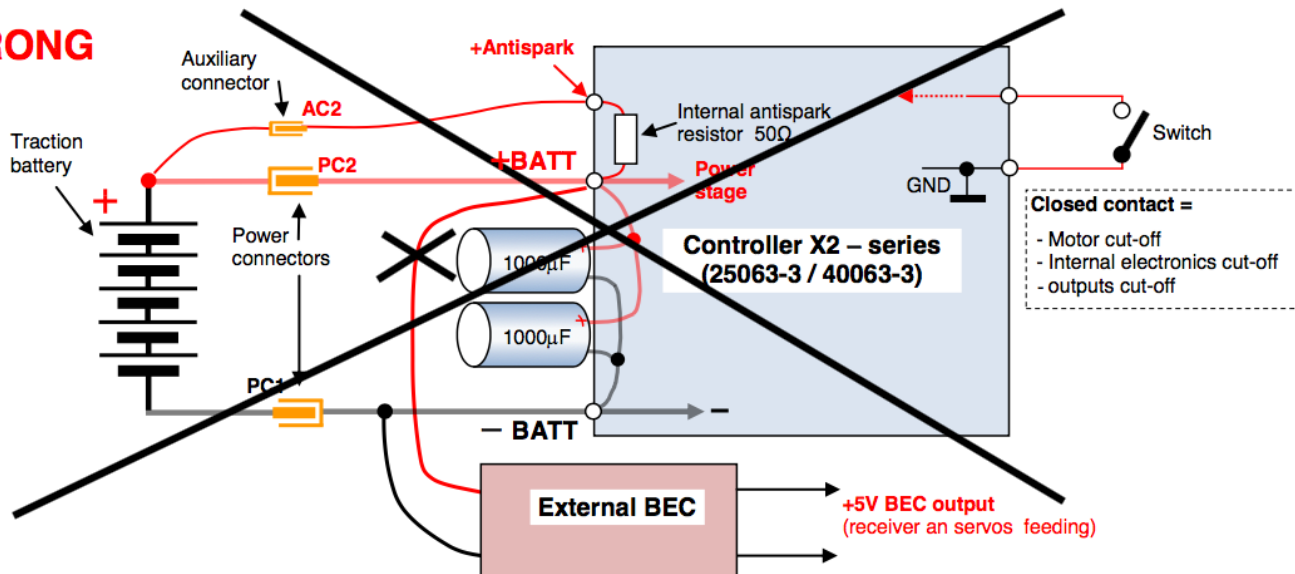

Solution 1: Either you use to connect an external BEC separate connector AC3 (switch) which is connected as shown below:

CORRECT

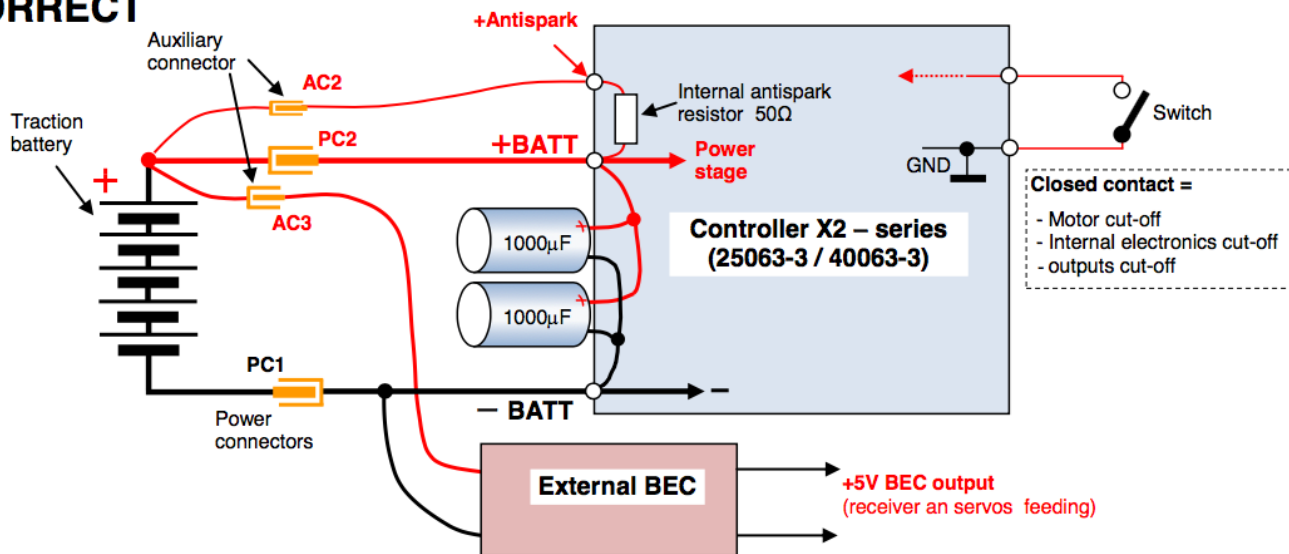

Solution 2: or use sufficient power sized antispark external resistor:

CORRECT

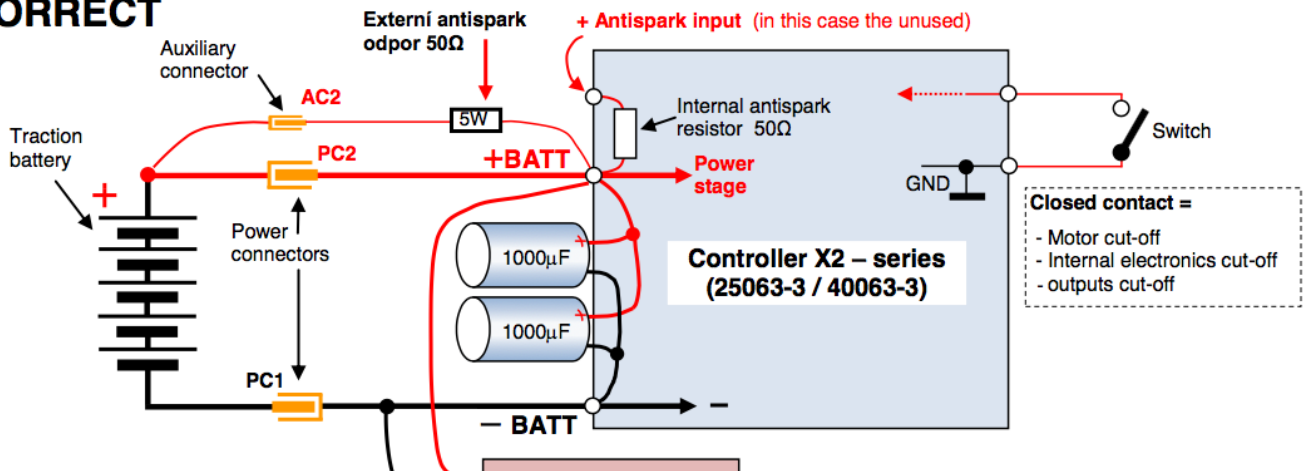

Protective and safety mechanisms of TMM® controllers

Controllers mask interference and signal losses for up to defined time in parameters. Motor revolutions are gradually reduced for longer lasting signal drop outs or interference. When the signal is restored, the controller goes smoothly back to the required power. Long lasting signal drop out (or its absence) is indicated acoustically by motor as well as by LED. This comes in handy when e.g. looking for a lost model.

Motor does not start, if the controller does not receive a correct signal from the receiver (e.g. when the transmitter is turned off). It also does not start until the throttle stick is not in „motor turned off“ position after switch on – that is in the neutral position for "grip pistols" transmitter type or „minimal throttle“ for transmitters without neutral.

Temperature fuse of the controller is set to ca 100°C.

Current fuses of the controller turn the controller off or limit the currents during current overload of the controller. New start, after fuse cut off, is possible after the throttle is moved back to neutral (minimal position for transmitters without neutral).

Circuits monitoring voltage take care of the correct moment for disconnecting the motor when the batteries get discharged – not only that the batteries do not get undercharged but also enough energy is retained for servos after the motor is turned off (when the battery is discharged).

Advantages of these mechanisms for TMM® controllers:

- 1) Thanks to the use of the automatic current fuse (**ACF**) the possibility of current overload of controller, motor and accumulators (and their possible damage) even at crisis points is significantly reduced - controller disconnects the motor.
- 2) the used system of intelligent power reduce (**IPR**) always ensures through measurements of voltage, currents, accumulator condition and calculations an optimal point of starting continuous reduction of motor performance (or the point when motor is switched off, according to the setting), so that the accumulator cells do not get extremely discharged – which is very important specially for Lipol cells. This, not mentioning other advantages, reduces the possibility of reversal of poles of lower cells (applies mainly to NiCd / NiMH cells).
- 3) This system at the same time **enables retaining defined energy for BEC (perfect RPC)** – applies to controllers with BEC. It is extremely important for flying models (you do not crash due to not having enough energy for receiver and servos). The amount of retained energy can be set by the user (by setting the switch-off voltage).
- 4) the automatic current reduce (**ACR**) does not allow a drop in voltage for BEC even under extremely big current load.

When switching the motor off (reducing power) at a solid boundary as it is with standard controllers (**chart a**) it is not possible to determine the amount of energy for BEC which is kept in the controller after the motor is switched off. It strongly depends on currents and inner resistance of the battery. The better the cells (harder) you have and the smaller the instantaneous current, the less energy (= time) remains for landing after the motor is switched off by the controller. On the other hand, the worse the cells and the higher the instantaneous currents, the more energy remain – but you do not know how much energy exactly.

Comparing to this, **TMM® controllers (chart b)** ensures that the remaining energy (after the motor is switched off by the controller) is practically independent on currents and inner resistance of the battery and it is possible to change its amount for some types of controllers according to one's needs (higher for gliders, etc.). From the motor operation time view it is usually an insignificant amount of energy, the motor power would decrease very fast anyway. However, this energy is very significant in regards to feeding BEC.

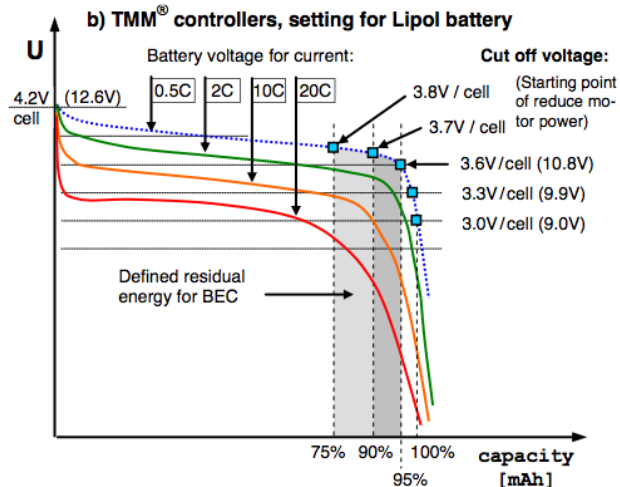
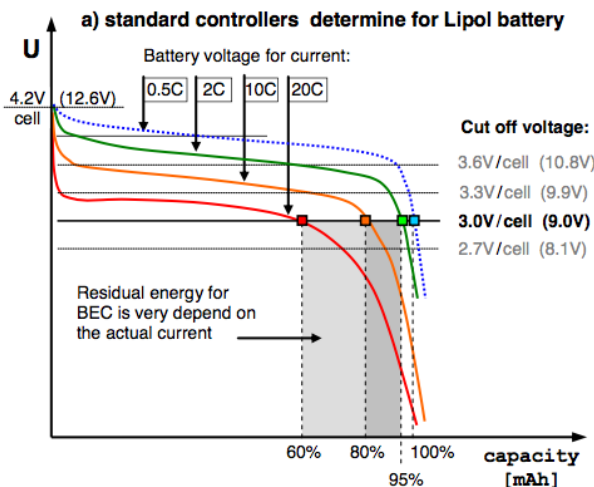

Regular controllers (even Lipol compatible) have either a solid switching off voltage (for example 3V per cell) or it is possible to set this value. For example for set boundary 3V per cell the controller is switch off or it starts to reduce revolutions when this value is reached no matter how big the drawn current is. **This means that the residual energy significantly changes according to a instantaneous current load of batteries** (and also according to inner resistance of the cells) from 0 to 95% - depending only on the set voltage boundary. If the example on the graph above is considered with a set boundary of 3V per cell the controller will switch off when drawn current is 20C when there is still 40% of energy still left, while for 5C current when only 5% of energy is left. For boundary of 3.3V per cell the controller would switch off for currents of 20C when only few percent of energy were consumed while for 5C after 92% of energy would be consumed.

TMM® controllers handle the situation quite differently. The switching off voltage is always recalculated into „inner“ voltage of the battery – therefore is independent on both drawn current as well as inner resistance of the accumulator. **This means the set residual energy is always the same and does not depend on currents and inner resistance of battery.** Batteries are then always discharged to same level, regardless how big currents are drawn. The value of set residual energy is therefore only little dependent on the features of battery and the discharging current. For example for switching voltage 3.7V per cell controller switches off the motor or starts to reduce revolutions always after 90% of energy is used up no matter if the drawn current is 20C or 5C. (The voltage of accumulator after switch of the current always rises to a value close to curve of 0.5V – this discharging curve is close to „inner“ voltage of battery. This curve describes how much the controller is discharged.

Switching-off voltage:

Thanks to the above described mechanisms, the switching—off voltage (always meant as switching-off voltage per cell !) of **TMM® controllers** is

Update SW inside the controller (firmware)

When you want make update firmware in you controller to newest available version, you need **USBCOM 4** module and **CC_11** cable (the same as for standard programming of parameters). **PC must be connected to internet.**



Starting sequence for firmware updating follows:

- 0. Connect USBCOM 4 module to PC and Start program **Controller 2** first. **Connect controller, but no turn-on yet.**

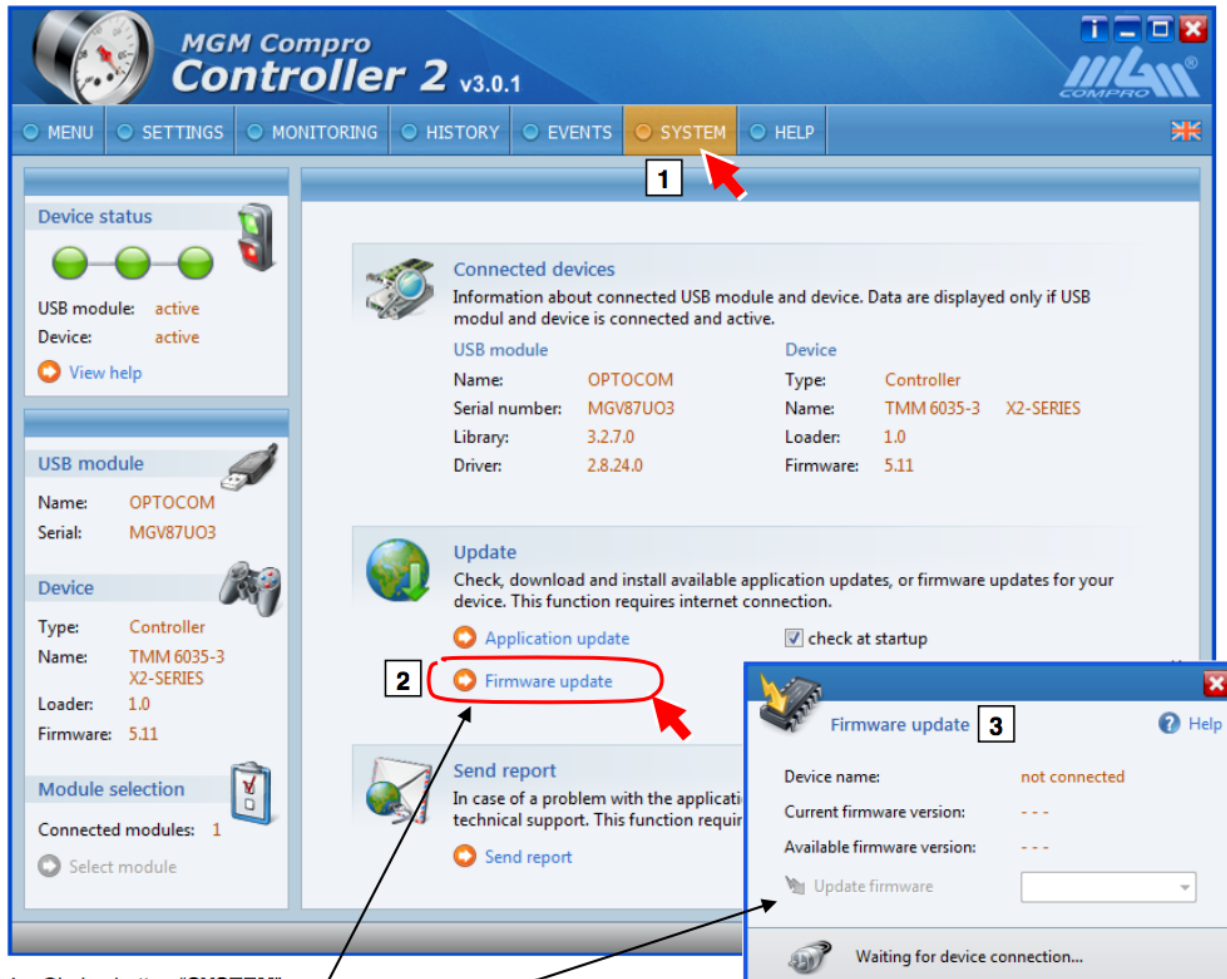

- 1. Choice button "SYSTEM"
- 2. Choice "Firmware update"
- 3. Windows "Firmware update" open
- 4. Turn-on your speed controller by its switch or applying main voltage. Your device version as well as available firmware version is displayed. **(If you already had the controller is switched on, now it must be switched off and on again)**

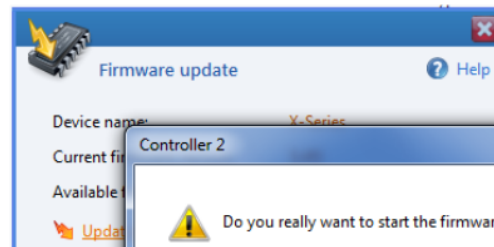
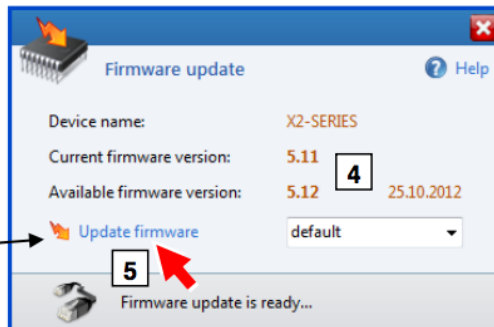
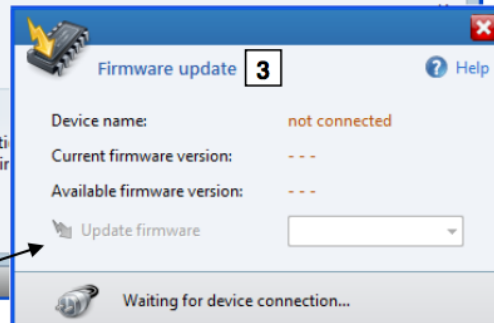

- 5. Push "Update firmware" button release.

7. Updating procedure start.

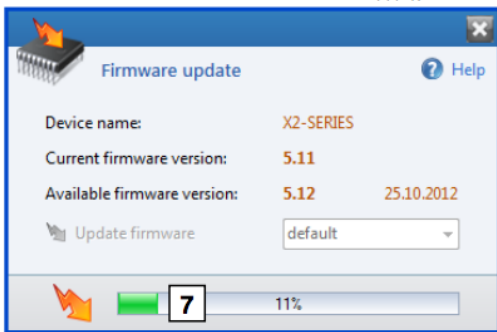

8b. when procedure corrupt (communication error etc.), is displayed this message Necessary start this update again.

8a. When procedure correctly finished, message will appear. Push OK.

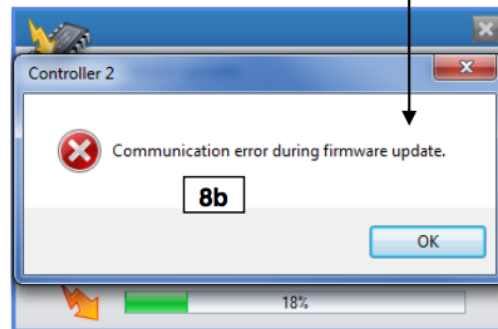
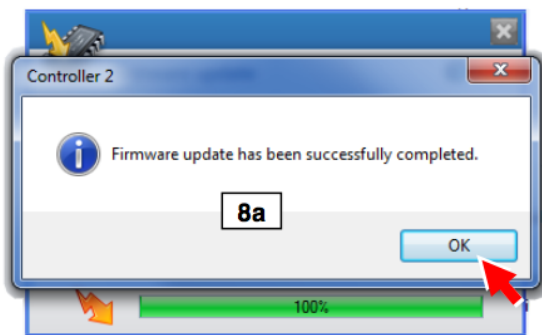

9. Follow next instruction.

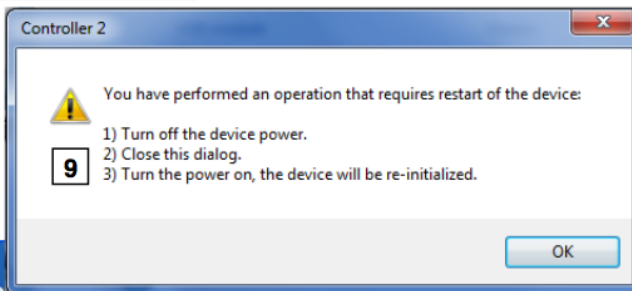

10. After restart device (your speed controller), newest version of its firmware is displayed. Update procedure is complete.



IMPORTANT:

You can start updating procedure for unlimited amount of tries, the controller cannot be broken down by failed update, but you have to finish the update procedure without errors [8a] if you want to use it with motor or parameter settings etc.

When procedure don't finished correctly [point 8b], controller (device) after next turn-on only slightly lights (glows) by blue LED. Controller don't work, not possible set parameters, etc. In this case is necessary this updating procedure repeat !

Installing and using program Controller 2

Are very simply and intuitive. Details are described in manual „*Installation and controlling of program Controller 2*“ (<http://www.mgm-controllers.com/downloads.html>), follow instructions in this manual please.

Update of program Controller 2

Update SW version of your program **Controller 2** is possible make by two ways. **In all cases is necessary active connecting PC to internet.**

1. After start program automatically advice to new version in left upper corner – start update by this way.

Choice "Download updates"

and push Update

OR

2. You can check if new version is available any time → click to **SYSTEM**, and **Application update**

3. When is new version available, click to **Yes**

4. Wait for finishing

5. Last step is restart, after this you have newest current version.

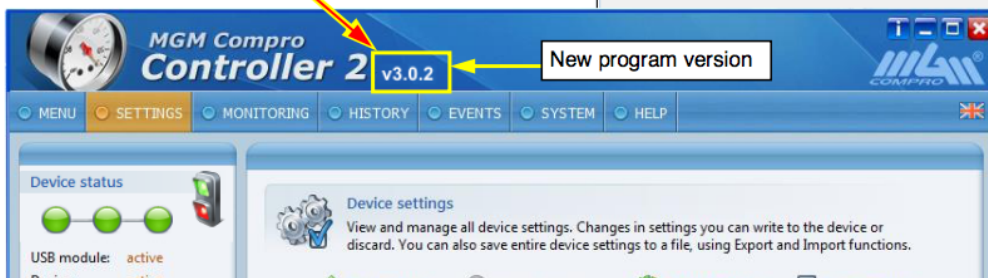
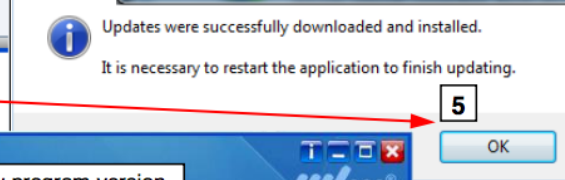
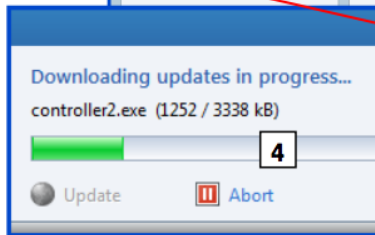
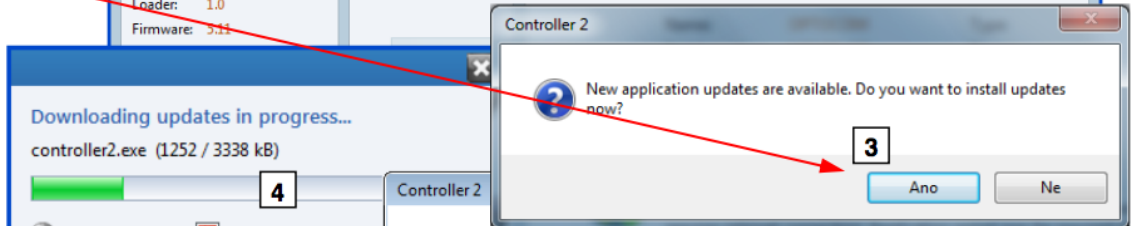
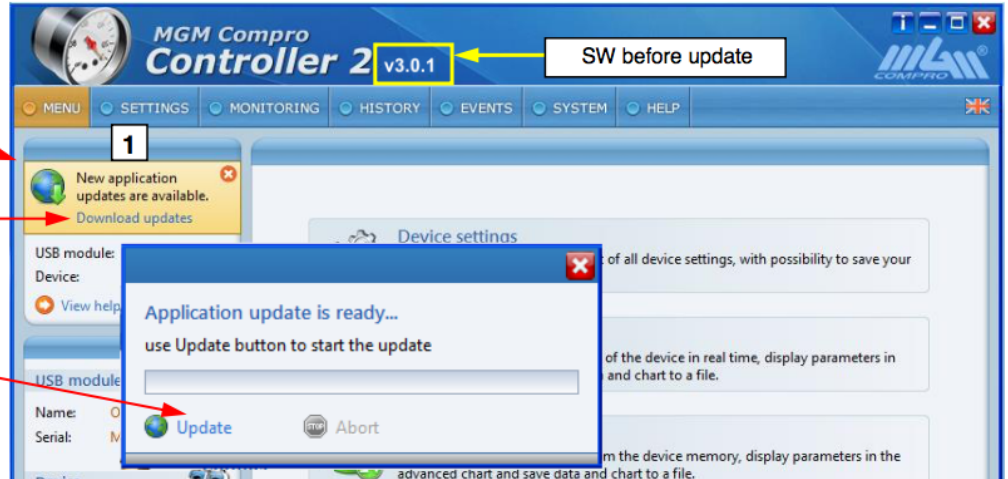

Accessories

Braking lights is possible order and connect to the controller. Available are three modification:

- with 2 high lighting LED (BL_02C)
- with 4 high lighting LED (BL_04C)
- with 4 high lighting AUTO LED (BL_04D) - Super brightness LED with wide viewing angle

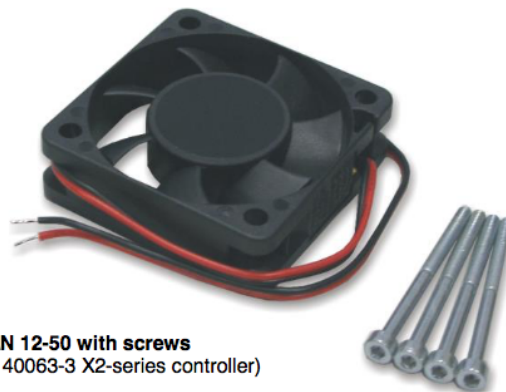
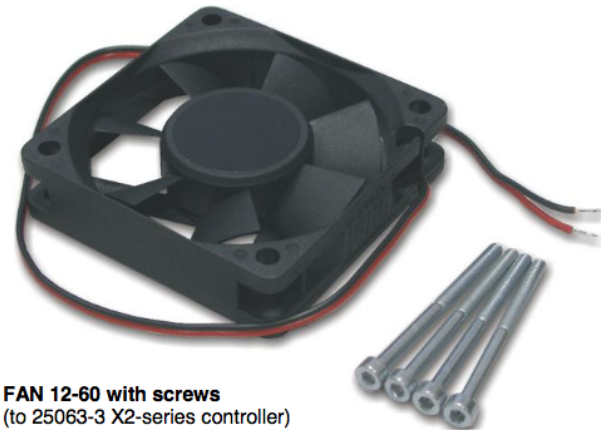
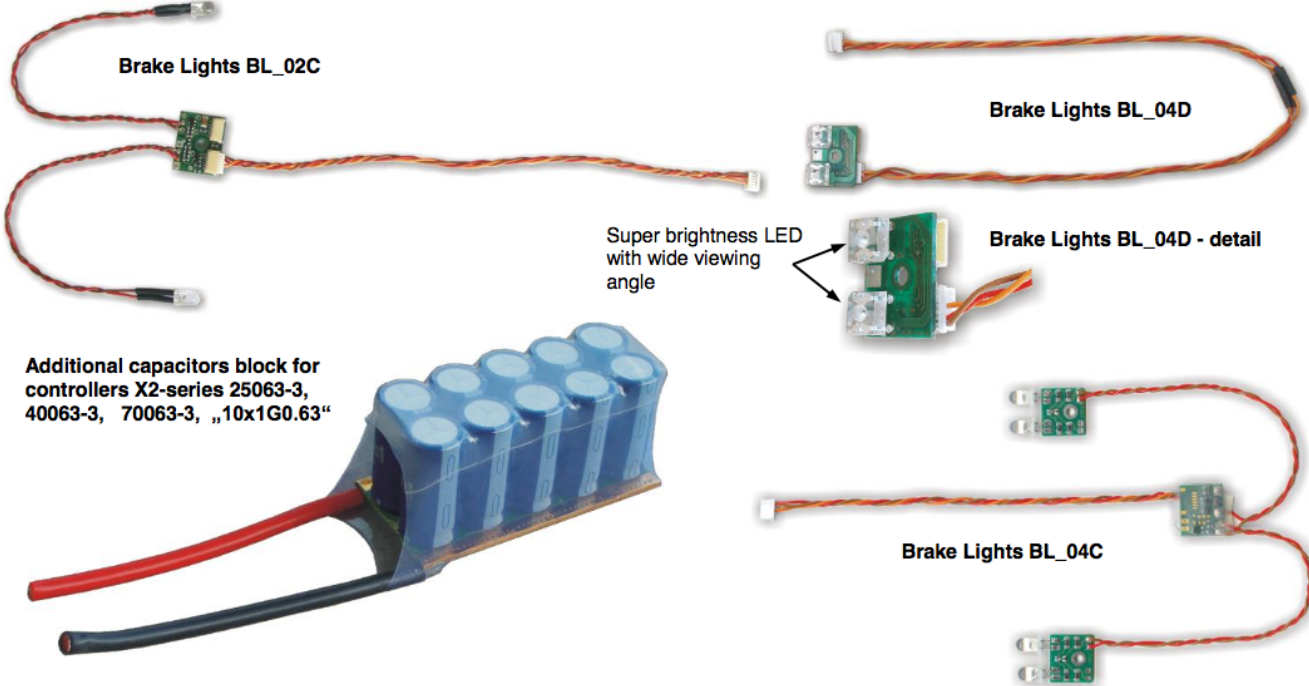

For mounting fan(s) to original cooler (on the controller) is possible use only enclosed screws. Use another type of fan or another screws for mounting to controller is strictly prohibited !

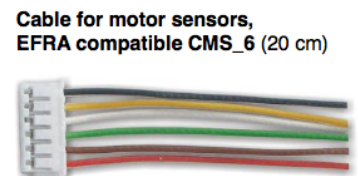

Power cables 10 mm², 16 mm² resp. 25 mm² with ring terminals
(screws, nuts and spacers include)

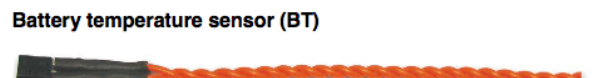

Content of delivery

- Controller in box
- CD with program **Controller 2**, with manual and other information
- Printed basic (general) information
- Warranty certificate

Product Warranty

MGM compro guarantees, this product to be free from factory defects in material and workmanship. Warranty period is of 24 months from date of purchase and purchase within the EU. Warranty for purchases made outside the EU is inline with the respective legal regulations. Warranty liability shall be limited to repairing or replacing the unit to our original specifications.

The warranty may be claimed under the following conditions:

The product has been used in the coherence with the instructions for use and only for purposes stated in the instructions and provided that none of the conditions for which the warranty cannot be claimed (see below) occurred.

It is necessary to provide together with the product for repair:

- a copy of sales receipt (if a warranty repair is claimed)
- detailed description of the problem – how it occurred and what is the problem
- description of the RC set you were using when the problem occurred (number of cells, their capacity, motor, throttle, etc.)
- your phone number and/or email address in order to allow further consultations regarding the problem

The warranty does not cover and therefore cannot be claimed for damages/destroys cause by:

- forced mechanical damage, crash of the model etc.
- chemical substances
- unqualified manipulation, incorrect installation
- any interference with the controller (soldering, change of wires, change components, exposed circuit board etc.)
- reversal of poles
- disconnecting from the battery (or switch-off) while the motor is still turning
- overloading with a higher number of cells than specified
- feeding from unspecified source (e.g. mains source instead of the specified cells)
- shortcut on the output
- overload
- water or any other substances (except "WR" version)
- salt water
- running with damaged motor
- operations with not recommended (not suitable) connectors
- not following the instruction in the manual or operating in conflict with recommendations or manual

The warranty also does not apply when:

- normal wear and tear
- acts of God (e.g. strike by lightning)

We do reserve the right to change our product warranty at any time without prior notice.

Service and Technical Support

Send product for service to address: **MGM compro, Sv. Čecha 593, 760 01 Zlín, Czech republic, EU**

Call your questions and requests to: **+420 577 001 350** or write on: mgm@mgm-controllers.com

Information about products, technical notes, news, recommendation: www.mgm-controllers.com

Update firmware and SW on: www.mgm-controllers.com

Recycling



This symbol on the product and / or accompanying documents mean that used electrical and electronic products should not be mixed with general household waste.

For proper treatment, recovery and recycling, please take these products to designated collection points, where they will be accepted on a free of charge basis.

Electromagnetic Conformity declaration



For these products of the X2-series family we confirm that the electromagnetic compatibility directives are met.